

SEAT and BACK CUSHIONS

plain



or

quilted

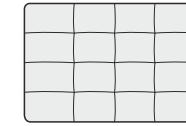

EXAMPLE quilted

2 SEATER with metal legs no.170

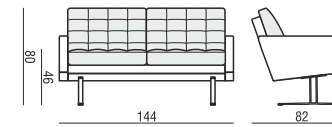

ARMRESTS

wood fabric

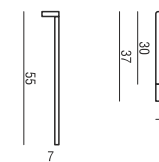

EXAMPLE

ARMCHAIR with WOOD ARMRESTS

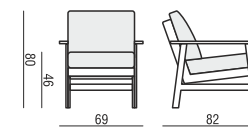

ELEMENT 55 + 2x ARMRESTS

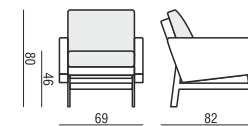

ELEMENT 65 LEFT (or RIHGT)

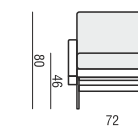

ELEMENT 65 without ARMRESTS

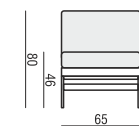

2 SEATER

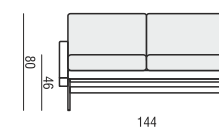

2 SEATER LEFT (or RIGHT)

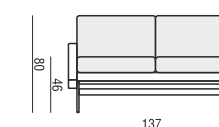

2 SEATER without ARMRESTS

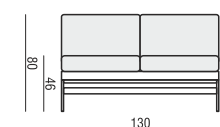

CORNER 90°

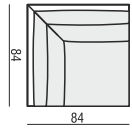

FOOTSTOOL 45x55

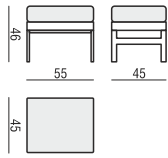

FOOTSTOOL 45x65

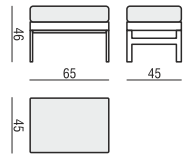

SET 1 LEFT (or RIGHT) ELEMENT 65 LEFT (or RIGHT) + CORNER 90° + 2 SEATER RIGHT (or LEFT)

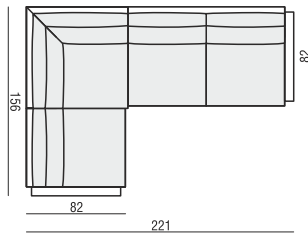

SET 2 2 SEATER LEFT + CORNER 90° + 2 SEATER RIGHT

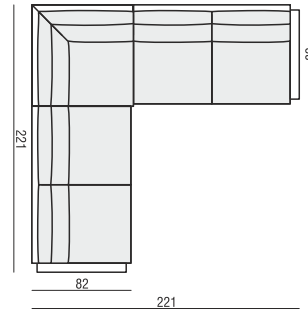

UPHOLSTERY FABRIC and LEATHER: FC - fix cover

FEET for fabric or wood armrests wooden legs (oak frame, color natur, bleached oak)

- | | | |
|-----------------------|-----------------------|----------------------------|
| no. 167A - element 65 | no. 167C - 2 seater | no. 167E - footstool 45x55 |
| no. 167B - element 55 | no. 167D - corner 90° | no. 167F - footstool 45x65 |

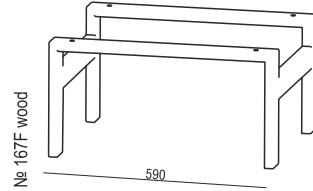
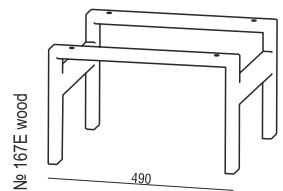
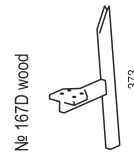
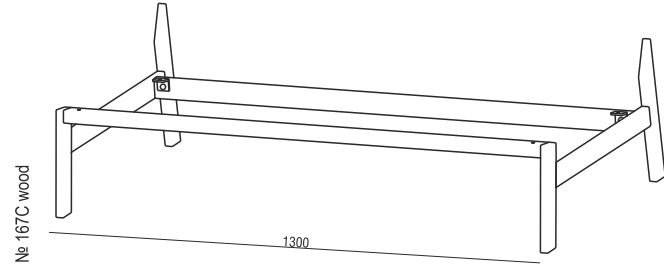
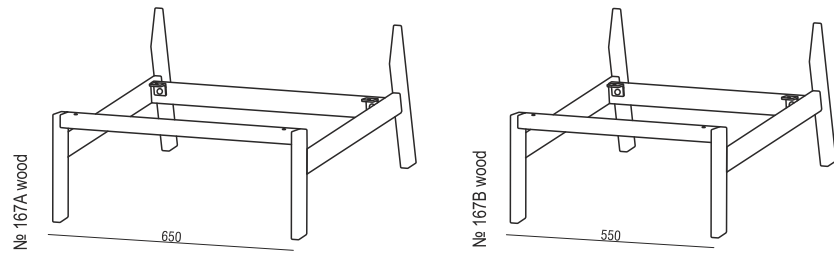

FEET

only for fabric armrests metal legs (black, grey, chrome and brushed steel)

- | | | |
|------------------------------|------------------------------|------------------------------|
| no. 168 - elements and sofas | no. 169 - elements and sofas | no. 170 - elements and sofas |
| no. 168A - corner 90° | no. 169A - corner 90° | no. 168A - corner 90° |
| no. 168B - footstool | no. 169B - footstool | no. 170B - footstool |

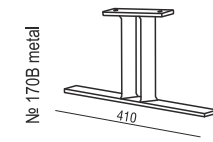
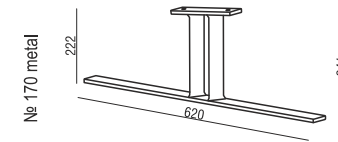
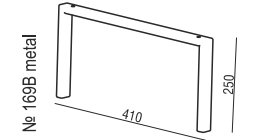
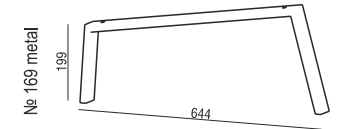
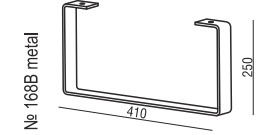
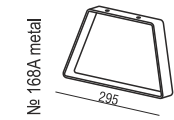
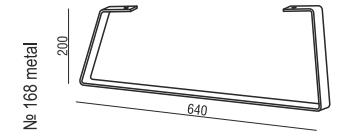

STANDARD COMFORT

1. polyurethane foam/high resilient polyurethane foam
2. upholstery belts
3. FSC® certified solid wood and wood based elements
4. fabric or leather
5. FSC certified solid wood or metal legs