

ARMCHAIR

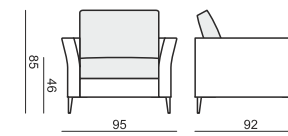

2 SEATER

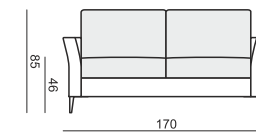

3 SEATER

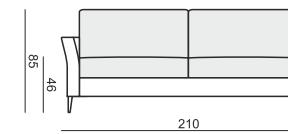

3,5 SEATER

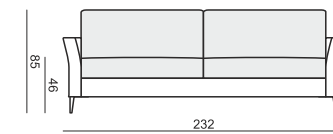

FOOTSTOOL

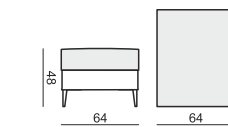

HEADREST with ROLL

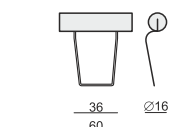

SET 1
2 SEATER LEFT + CORNER 90°
+ 2 SEATER RIGHT

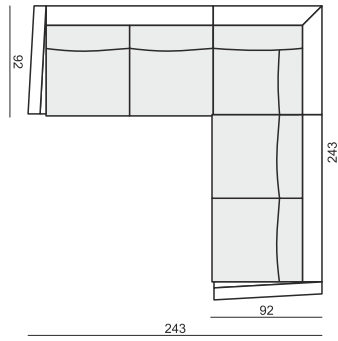

SET 2 LEFT (or RIGHT)
2 SEATER LEFT (or RIGHT) + CORNER 90°
+ 3 SEATER RIGHT (or LEFT)

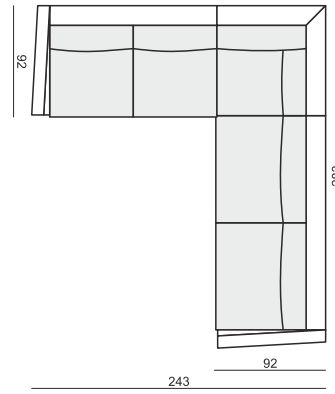

SET 3
3 SEATER LEFT + CORNER 90°
+ 3 SEATER RIGHT

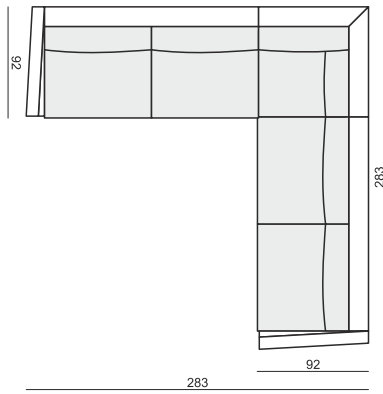

SET 4 RIGHT (or LEFT)
3 SEATER LEFT (or RIGHT) + DIVAN RIGHT (or LEFT)

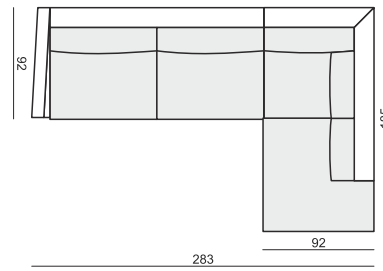

SET 5 RIGHT (or LEFT)
2 SEATER LEFT (or RIGHT) + DIVAN RIGHT (or LEFT)

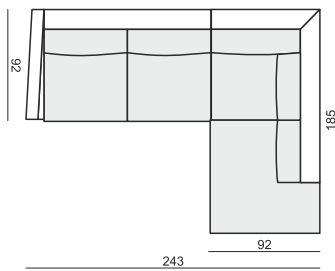

SET 6 RIGHT (or LEFT)
3,5 SEATER LEFT (or RIGHT) + DIVAN RIGHT (or LEFT)

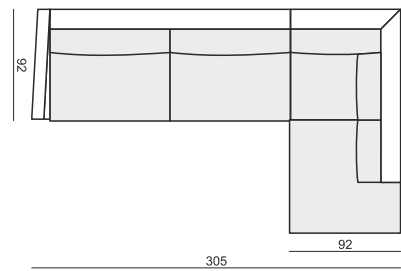

UPHOLSTERY FABRIC: FC - fix cover or LC - loose cover

FEET

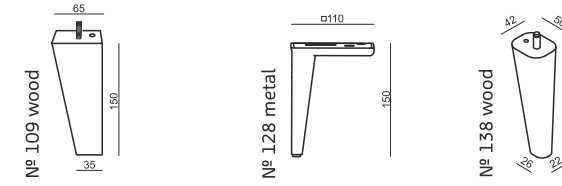

STANDARD COMFORT

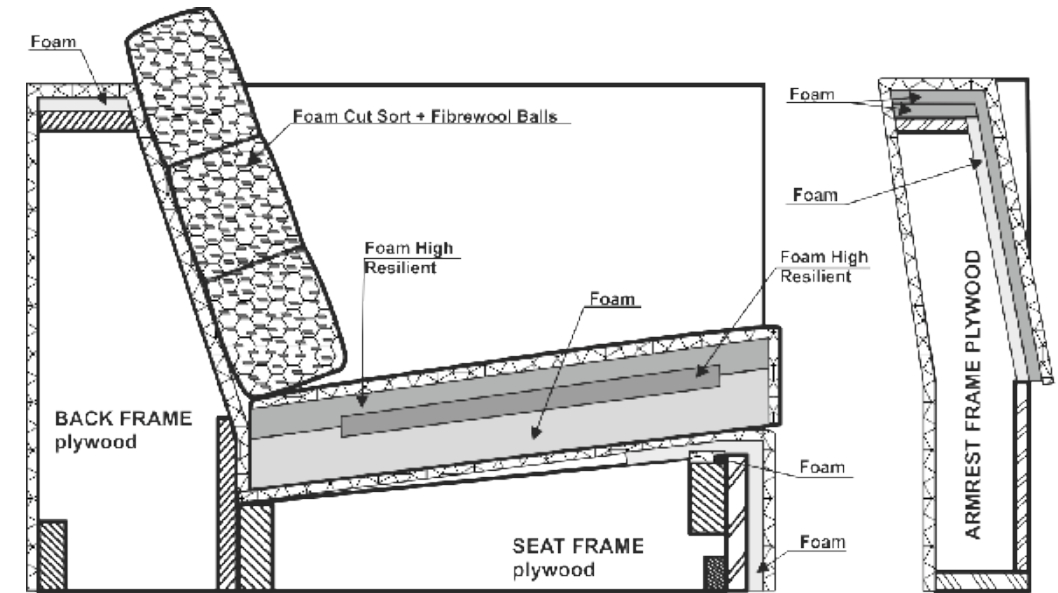

LUX COMFORT

