

ARMCHAIR

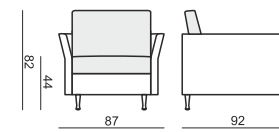

2 SEATER

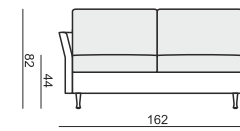

2,5 SEATER

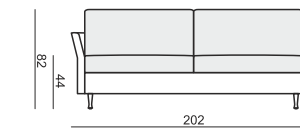

3 SEATER

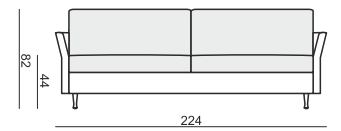

FOOTSTOOL

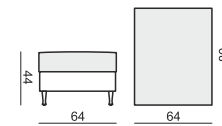

CUSHION

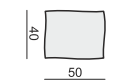

SET 1
2 SEATER LEFT + CORNER 90° + 2 SEATER RIGHT

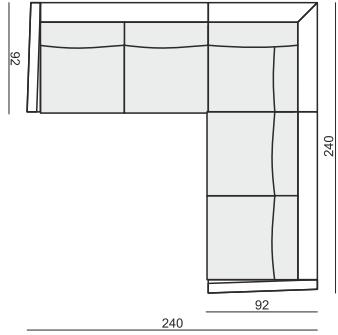

SET 2 LEFT (or RIGHT)
2 SEATER LEFT (or RIGHT) + CORNER 90°
+ 2,5 SEATER RIGHT (or LEFT)

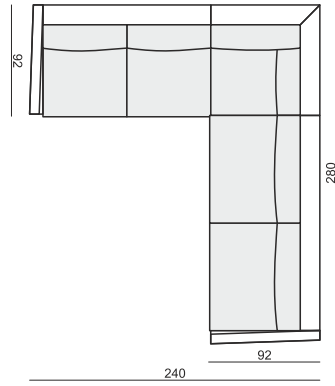

SET 3
2,5 SEATER LEFT + CORNER 90° + 2,5 SEATER RIGHT

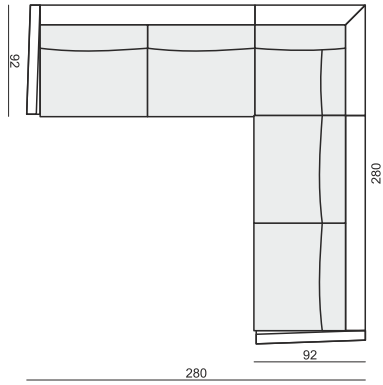

SET 4 RIGHT (or LEFT)
2,5 SEATER LEFT (or RIGHT) + DIVAN RIGHT (or LEFT)

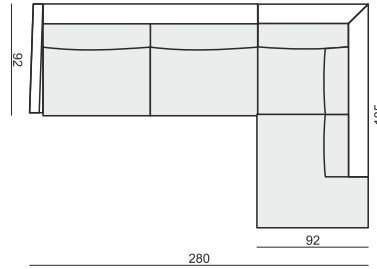

SET 5 RIGHT (or LEFT)
2 SEATER LEFT (or RIGHT) + DIVAN RIGHT (or LEFT)

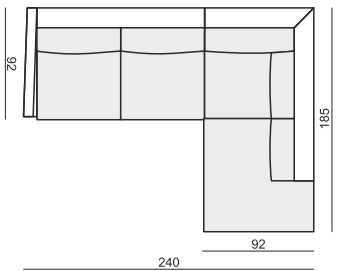

SET 6 LEFT (or RIGHT)
DIVAN LEFT (or RIGHT) + 3 SEATER RIGHT (or LEFT)

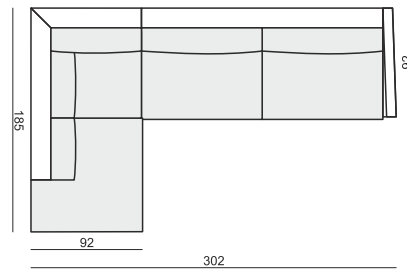

SET 7 LEFT (or RIGHT)
CHAISELONGUE 90 LEFT (or RIGHT) + 3 SEATER RIGHT (or LEFT)

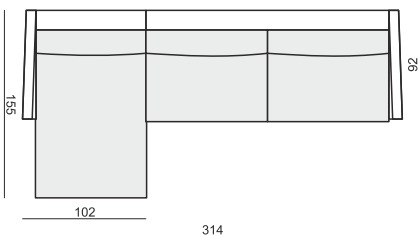

SET 8 LEFT (or RIGHT)
CHAISELONGUE 90 LEFT (or RIGHT) + 2,5 SEATER RIGHT (or LEFT)

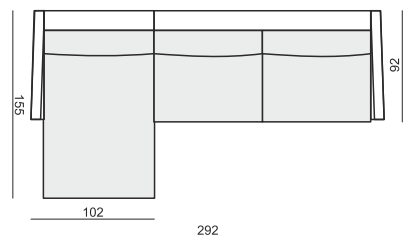

SITS reserves the right to change construction of products and components used due to improving durability of product and customer satisfaction without any further notice. Explicit ±2 cm tolerance of all elements sizes.

SET 9 LEFT (or RIGHT)
CHAISELONGUE 70 LEFT (or RIGHT) + 2 SEATER RIGHT (or LEFT)

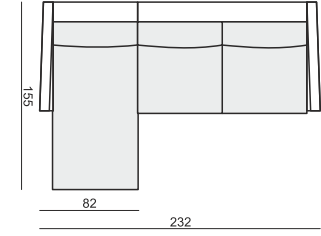

SET 10
DIVAN LEFT + 2,5 SEATER without ARMRESTS + DIVAN RIGHT

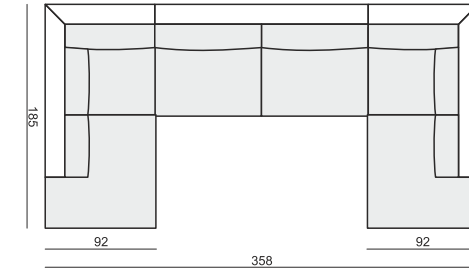

UPHOLSTERY

FABRIC: FC - fix cover

FEET

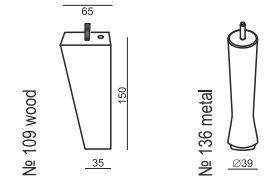

STANDARD COMFORT

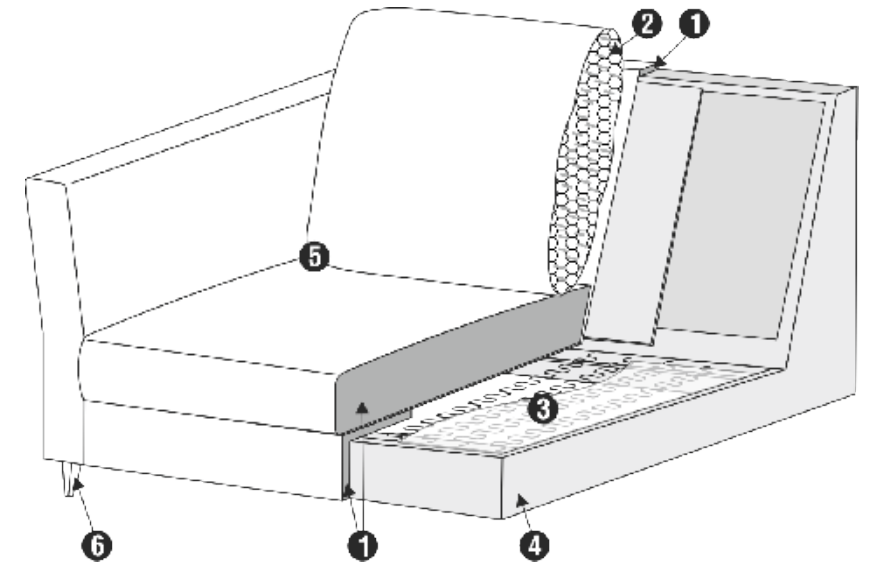

1. polyurethane foam / high resilient polyurethane foam
2. foam flakes with silicone balls
3. springs
4. solid wood and wood based elements
5. fabric
6. solid wood/ metal legs

LUX COMFORT

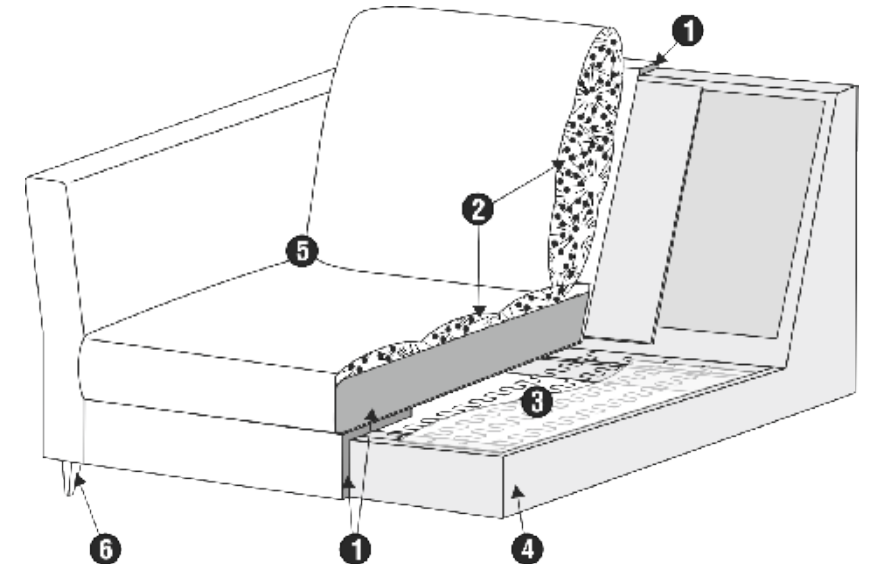

1. polyurethane foam / high resilient polyurethane foam
2. cushion chamber with mix of feather and silicone balls
3. springs
4. solid wood and wood based elements
5. fabric
6. solid wood/ metal legs