

ARMCHAIR

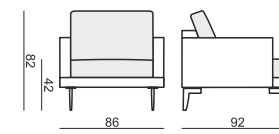

2 SEATER

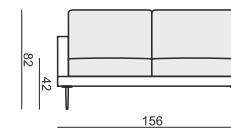

3 SEATER (2 CUSHIONS)

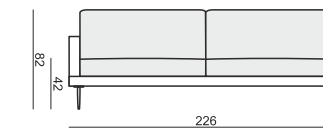

3 SEATER (3 CUSHIONS)



FOOTSTOOL

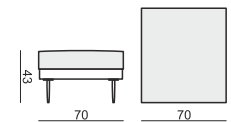

SET 1 RIGHT (or LEFT)
3 SEATER (3 CUSHIONS) LEFT (or RIGHT)
+ CHAISELONGUE RIGHT (or LEFT)

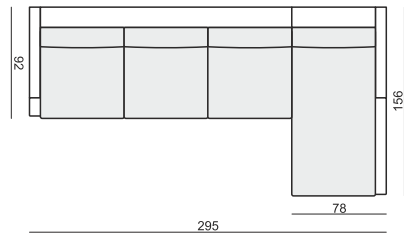

SET 2 RIGHT (or LEFT)
2 SEATER LEFT (or RIGHT)
+ CHAISELONGUE RIGHT (or LEFT)

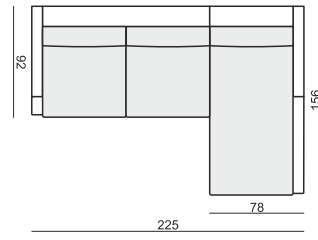

SET 3 RIGHT (or LEFT)
3 SEATER (3 CUSHIONS) LEFT (or RIGHT)
+ DIVAN RIGHT (or LEFT)

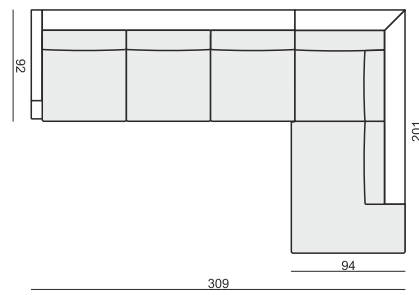

SET 4 RIGHT (or LEFT)
2 SEATER LEFT (or RIGHT) + DIVAN RIGHT (or LEFT)

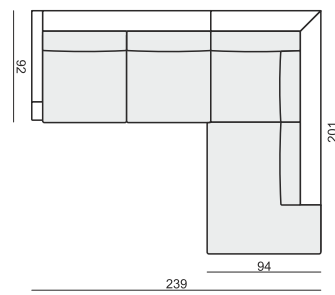

SET 5 RIGHT (or LEFT)
3 SEATER (2 CUSHIONS) LEFT (or RIGHT)
+ CHAISELONGUE WIDE RIGHT (or LEFT)

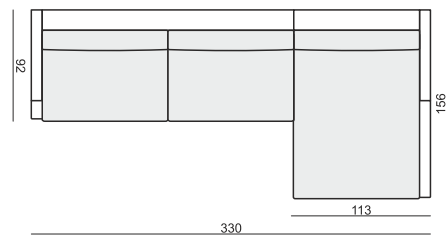

SET 6 RIGHT (or LEFT)
3 SEATER (2 CUSHIONS) LEFT (or RIGHT)
+ DIVAN RIGHT (or LEFT)

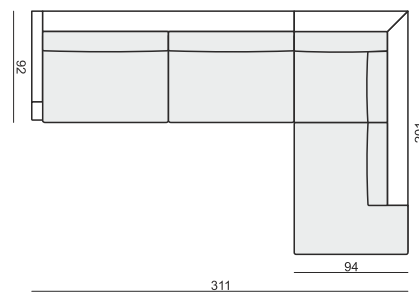

SITS reserves the right to change construction of products and components used due to improving durability of product and customer satisfaction without any further notice. Explicit ±2 cm tolerance of all elements sizes.



UPHOLSTERY

FABRIC: FC - fix cover

FEET

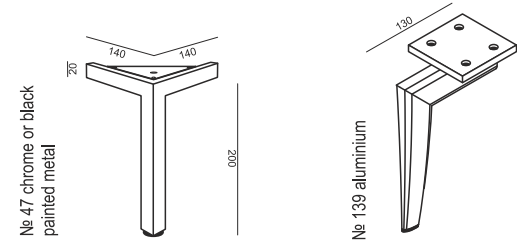

STANDARD COMFORT

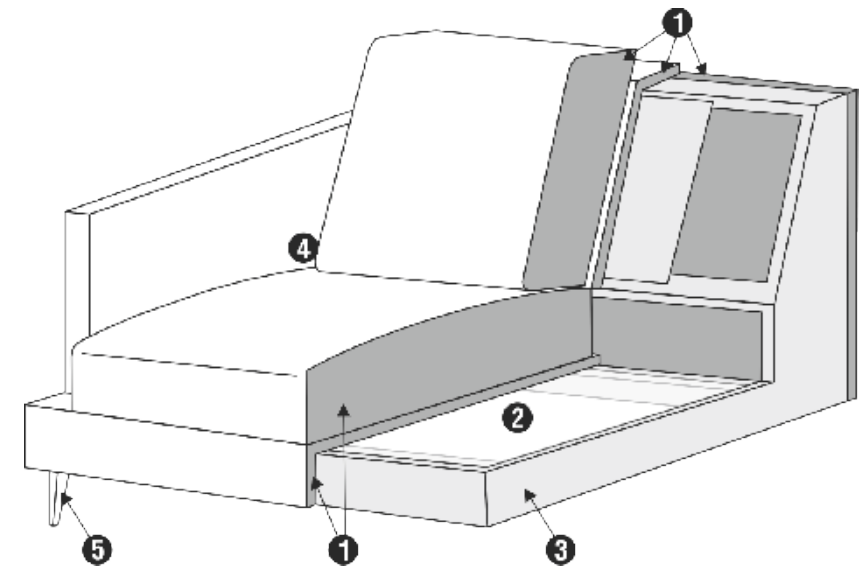

1. polyurethane foam/high resilient polyurethane foam
2. dynaflex - elastic fabric
3. FSC certified solid wood and wood based elements
4. fabric
5. metal legs