

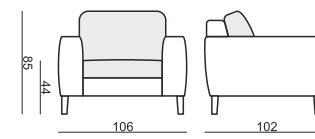

ARMCHAIR

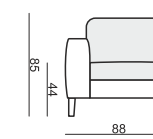

ARMCHAIR LEFT (or RIGHT)



ARMCHAIR without ARMRESTS

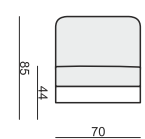

ARMCHAIR WIDE

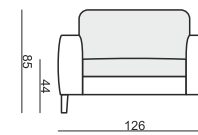

ARMCHAIR WIDE LEFT (or RIGHT)

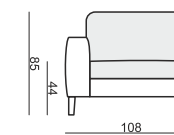

ARMCHAIR WIDE without ARMRESTS

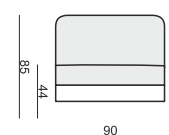

2 SEATER

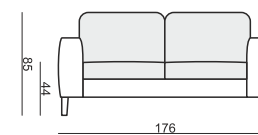

2 SEATER LEFT (or RIGHT)

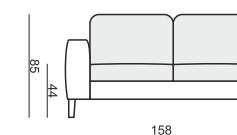

2 SEATER without ARMRESTS

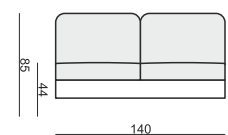

3 SEATER

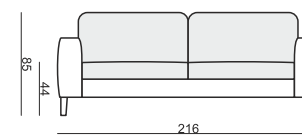

3 SEATER LEFT (or RIGHT)

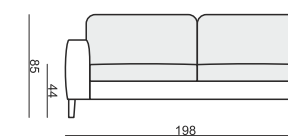

3 SEATER without ARMRESTS

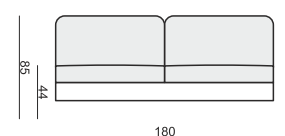

CHAISELONGUE LEFT (or RIGHT)

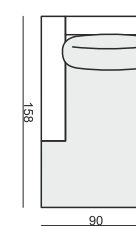

CHAISELONGUE WIDE LEFT (or RIGHT)

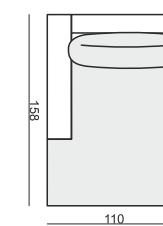

DIVAN LEFT (or RIGHT)

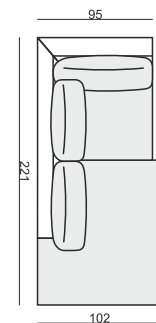

COZY CORNER LEFT (or RIGHT)

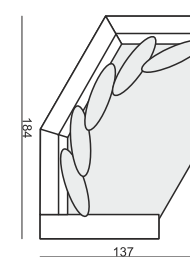

CORNER 90° No.1

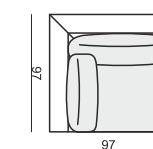

CORNER 90° No.2

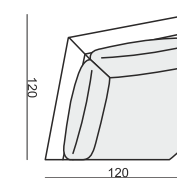

FOOTSTOOL

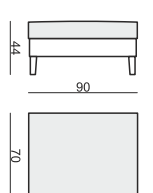

ENDPART LEFT (or RIGHT)
cm 95 x 4 x 58 H

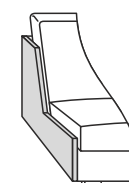

HEADREST L-77

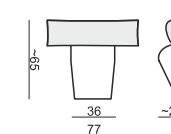

HEADREST L-62

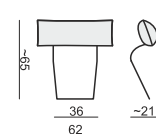

SET 1 LEFT (or RIGHT)
CHAISELONGUE LEFT (or RIGHT) + 2 SEATER RIGHT (or LEFT)

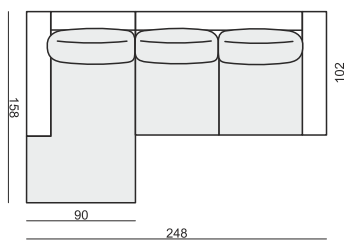

SET 2 LEFT (or RIGHT)
CHAISELONGUE WIDE LEFT (or RIGHT) + 3 SEATER RIGHT (or LEFT)

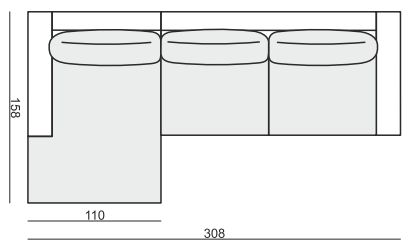

SET 3 LEFT (or RIGHT)
DIVAN LEFT (or RIGHT) + 2 SEATER RIGHT (or LEFT)

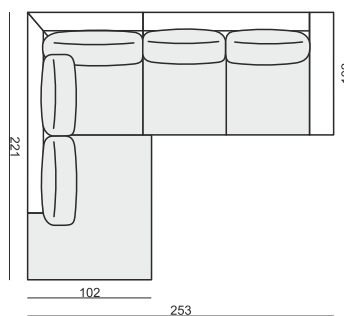

SET 4 LEFT (or RIGHT)
DIVAN LEFT (or RIGHT) + 3 SEATER RIGHT (or LEFT)

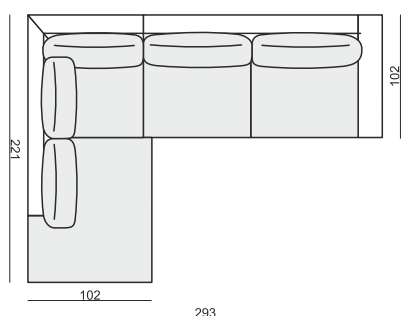

SET 5 LEFT (or RIGHT)
COZY CORNER LEFT (or RIGHT) + 3 SEATER RIGHT (or LEFT)

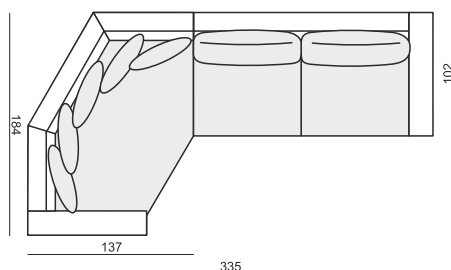

SET 6
DIVAN LEFT + 2 SEATER without ARMRESTS + DIVAN RIGHT

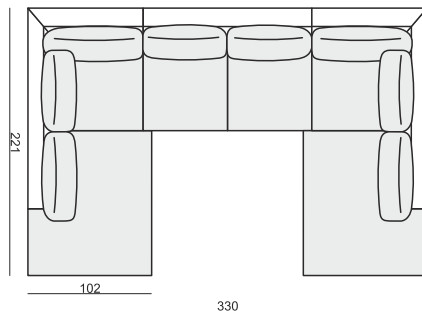

SET 7 LEFT (or RIGHT)
DIVAN LEFT (or RIGHT) + 2 SEATER without ARMRESTS
+ CHAISELONGUE RIGHT (or LEFT)

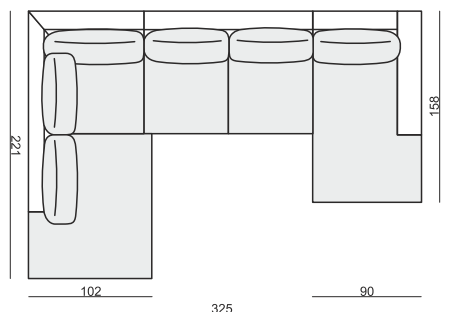

SET 8 LEFT (or RIGHT)
2 SEATER LEFT (or RIGHT) + CORNER 90° No.1
+ 3 SEATER RIGHT (or LEFT)

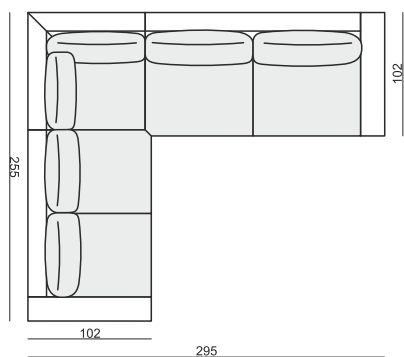

SITS reserves the right to change construction of products and components used due to improving durability of product and customer satisfaction without any further notice. Explicit ±2 cm tolerance of all elements sizes.

SET 9 LEFT (or RIGHT)
2 SEATER LEFT (or RIGHT) + CORNER 90° No.2
+ 3 SEATER RIGHT (or LEFT)

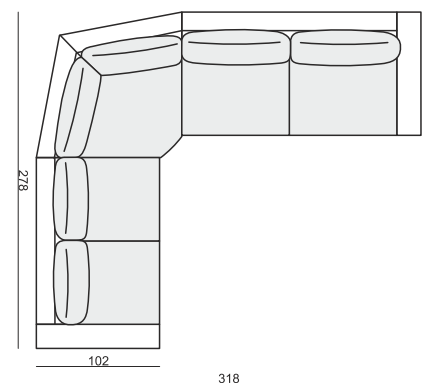

SET 10 LEFT (or RIGHT)
CHAISELONGUE LEFT (or RIGHT) + 2 SEATER without ARMRESTS
+ CORNER 90° No.1 + 2 SEATER RIGHT (or LEFT)

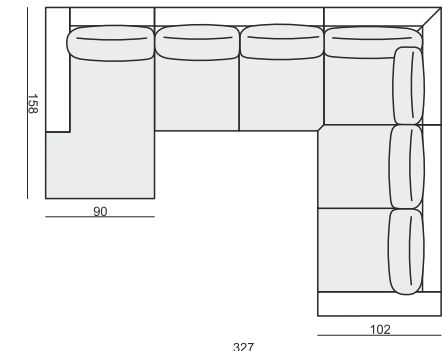

UPHOLSTERY

FABRIC: FC - fix cover or LC - loose cover

FEET

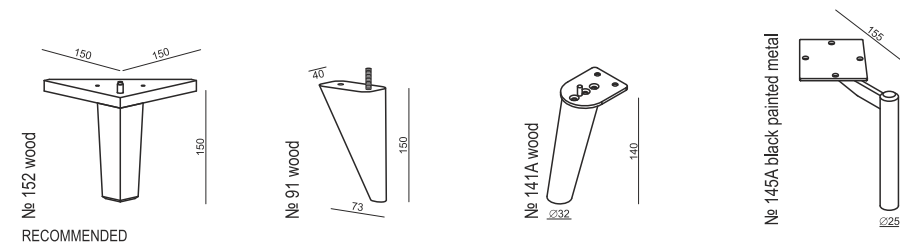

STANDARD COMFORT

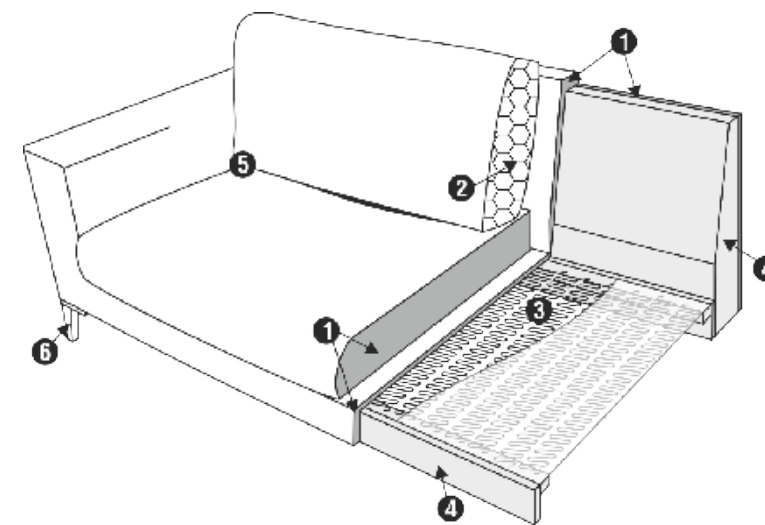

1. polyurethane foam/ high resilient polyurethane foam
2. silicone balls lux
3. springs
4. FSC certified solid wood and wood based elements
5. fabric
6. FSC certified solid wood or metal legs

LUX COMFORT

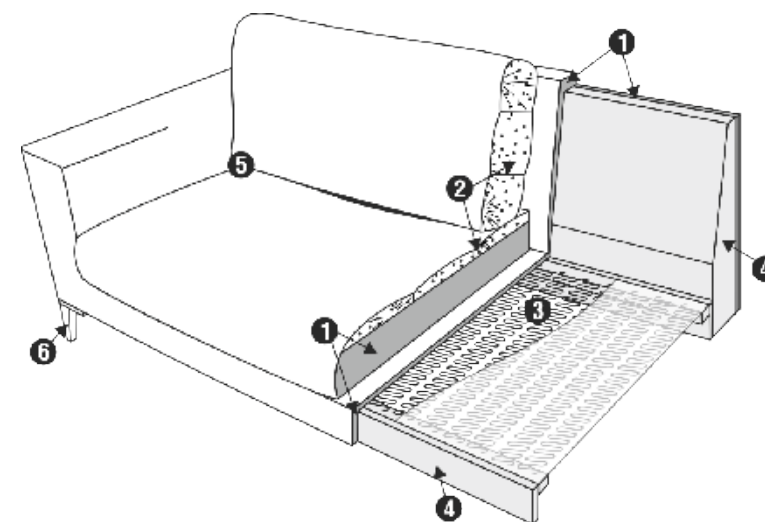

1. polyurethane foam/ high resilient polyurethane foam
2. cushion chamber with mix of feather and silicone balls
3. springs
4. FSC certified solid wood and wood based elements
5. fabric
6. FSC certified solid wood or metal legs