

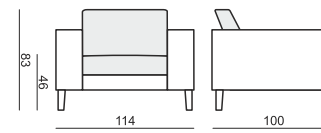

ARMCHAIR

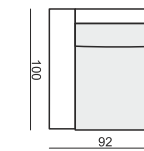

ARMCHAIR LEFT (or RIGHT)



ARMCHAIR without ARMRESTS

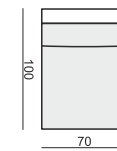

2 SEATER

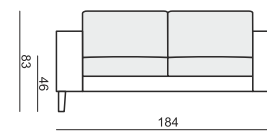

2 SEATER LEFT (or RIGHT)

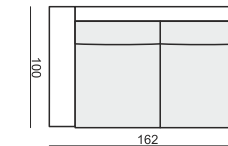

2 SEATER without ARMRESTS

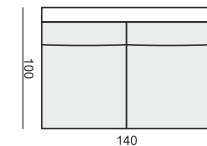

3XL SEATER

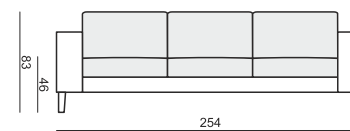

3XL SEATER LEFT (or RIGHT)

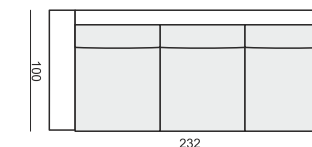

3XL SEATER without ARMRESTS

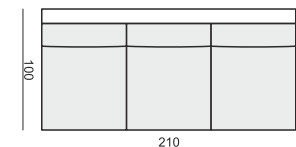

ARMCHAIR WIDE

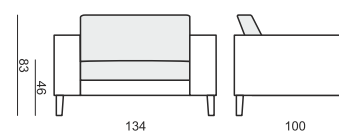

ARMCHAIR WIDE LEFT (or RIGHT)

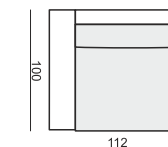

ARMCHAIR WIDE without ARMRESTS

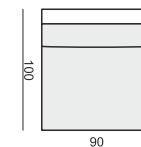

3 SEATER

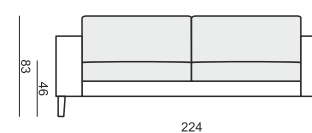

3 SEATER LEFT (or RIGHT)

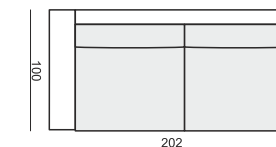

3 SEATER without ARMRESTS

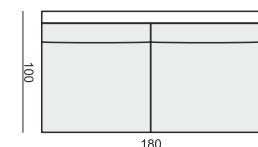

CHAISELONGUE LONG LEFT (or RIGHT)

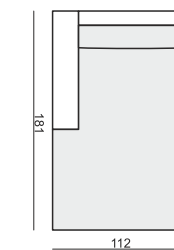

CHAISELONGUE LEFT (or RIGHT)

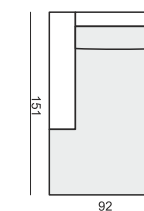

BENCH LEFT (or RIGHT)

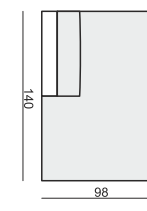

FOOTSTOOL 100x90

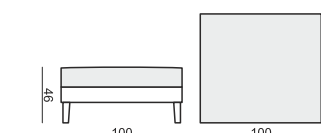

FOOTSTOOL 90x70

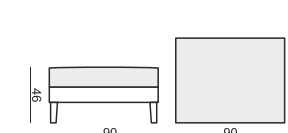

CORNER 90°

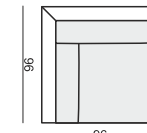

HEADREST L-50 x Ø15

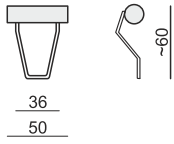

HEADREST L-70 x Ø15

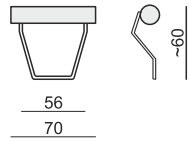

ENDPART

LEFT (or RIGHT)
94 x 48 x 2,5 cm

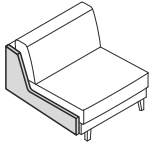

SET 1 LEFT (or RIGHT) CHAISELONGUE LEFT (or RIGHT) + 2 SEATER RIGHT (or LEFT)

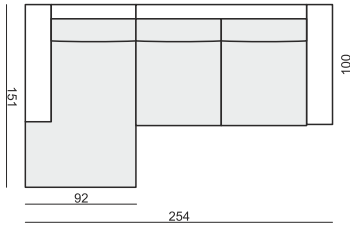

SET 2 LEFT (or RIGHT) CHAISELONGUE LONG LEFT (or RIGHT) + 3 SEATER RIGHT (or LEFT)

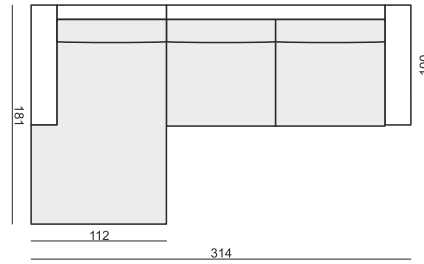

SET 3 2 SEATER LEFT + CORNER 90° + 2 SEATER RIGHT

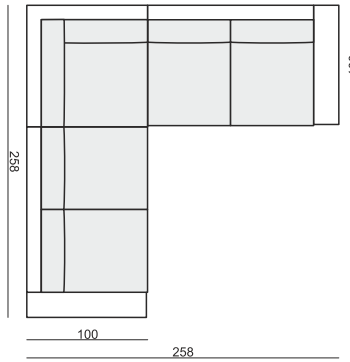

SET 4 3 SEATER LEFT + CORNER 90° + 3 SEATER RIGHT

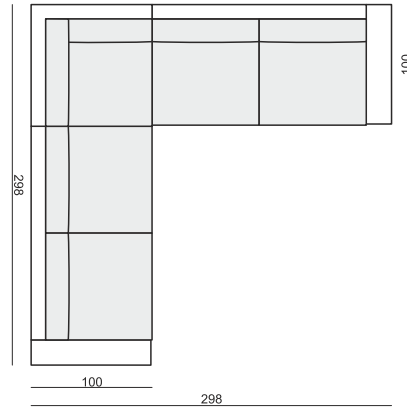

SET 5 LEFT (or RIGHT) 2 SEATER LEFT (or RIGHT) + CORNER 90° + 3 SEATER RIGHT (or LEFT)

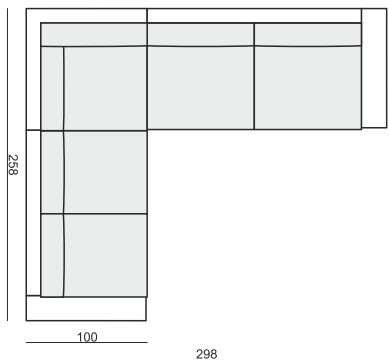

SITS reserves the right to change construction of products and components used due to improving durability of product and customer satisfaction without any further notice. Explicit ±2 cm tolerance of all elements sizes.

SET 6 LEFT (or RIGHT) BENCH LEFT (or RIGHT) + CORNER 90° + 3 SEATER RIGHT (or LEFT)

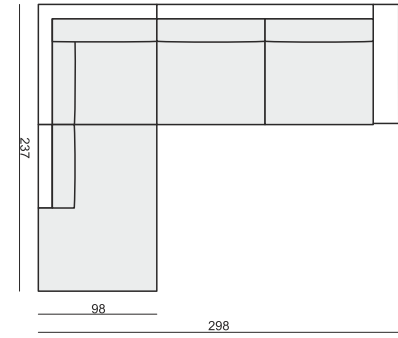

SET 7 LEFT (or RIGHT) BENCH LEFT (or RIGHT) + CORNER 90° + 2 SEATER RIGHT (or LEFT)

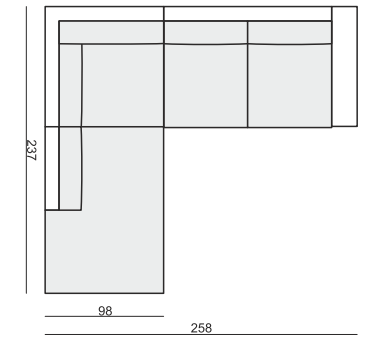

UPHOLSTERY

FABRIC: FC - fix cover

FEET

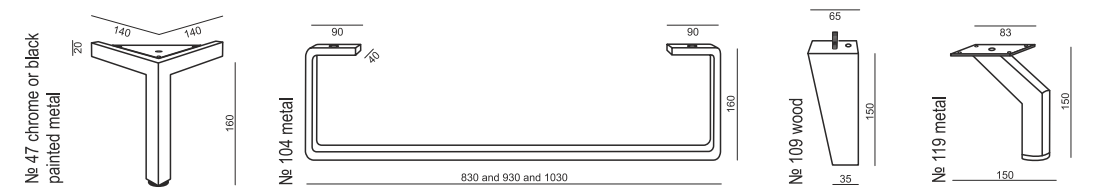

RICH COMFORT

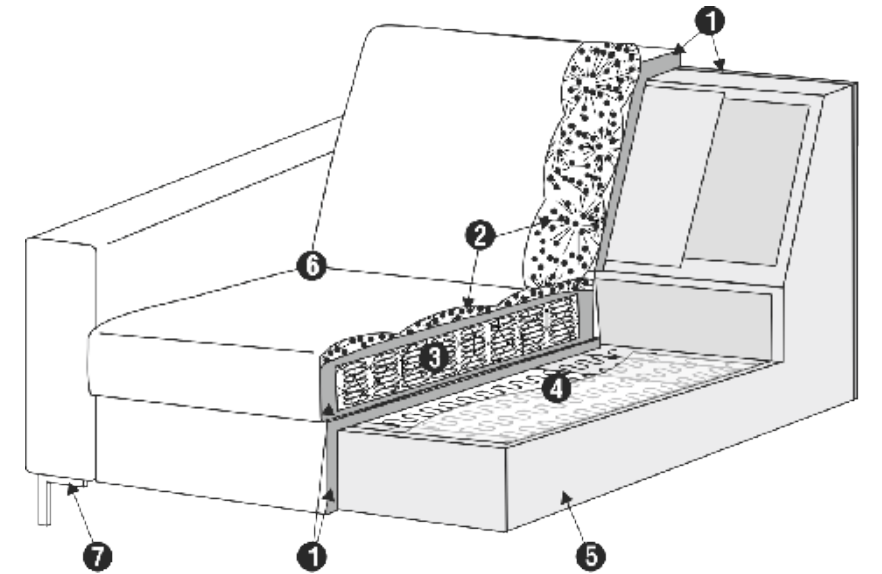

1. polyurethane foam/high resilient polyurethane foam
2. cushion chamber with mix of feather and silicone balls
3. bonnell springs
4. springs
5. solid wood and wood based elements
6. fabric
7. solid wood/metal legs

PREMIUM COMFORT

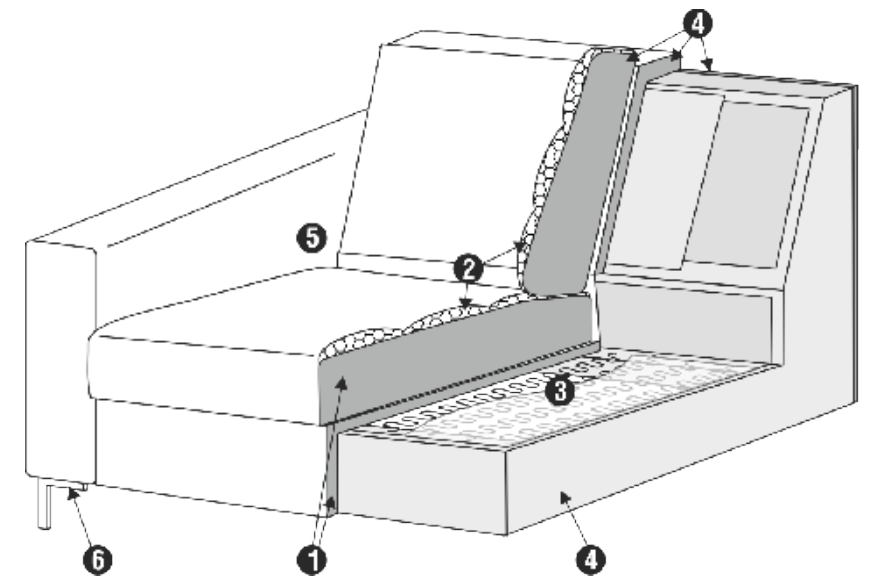

1. polyurethane foam/high resilient polyurethane foam
2. silicone balls
3. solid wood and wood based elements
4. fabric
5. solid wood/ metal legs