

ARMCHAIR

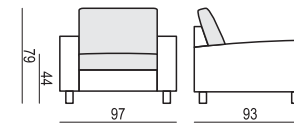

ARMCHAIR LEFT (or RIGHT)

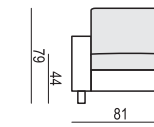

ARMCHAIR without ARMRESTS

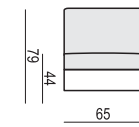

2 SEATER

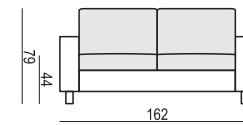

2 SEATER LEFT (or RIGHT)

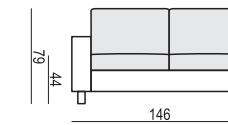

2 SEATER without ARMRESTS

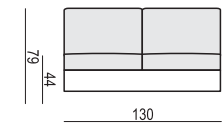

2,5 SEATER

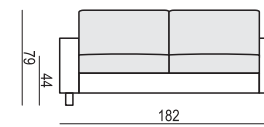

2,5 SEATER LEFT (or RIGHT)

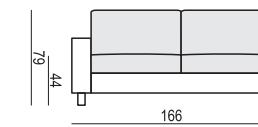

2,5 SEATER without ARMRESTS

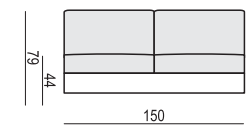

3 SEATER

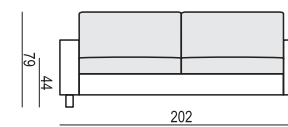

3 SEATER LEFT

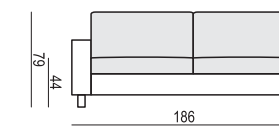

3 SEATER without ARMRESTS

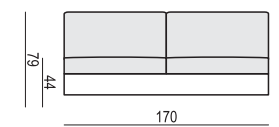

DIVAN LEFT (or RIGHT)

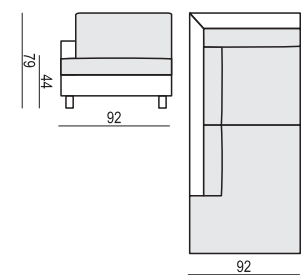

CHAISELONGUE LEFT (or RIGHT)

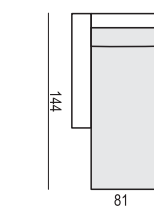

CORNER 90°

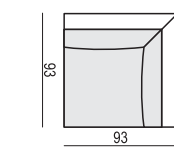

FOOTSTOOL

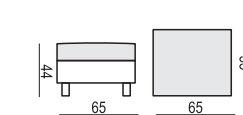

HEADREST with ROLL

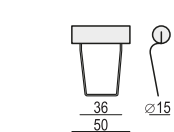

ARMREST INDY

cm 22 x 89 x 48 H

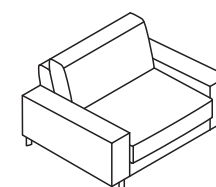

ARMREST IMOLA

cm 16 x 89 x 48 H

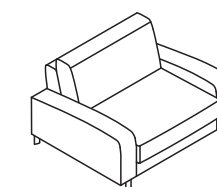

ARMREST MONZA

cm 17 x 89 x 52 H

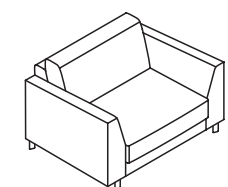

SET 2 LEFT (or RIGHT)
DIVAN LEFT (or RIGHT) + 3 SEATER RIGHT (or LEFT)

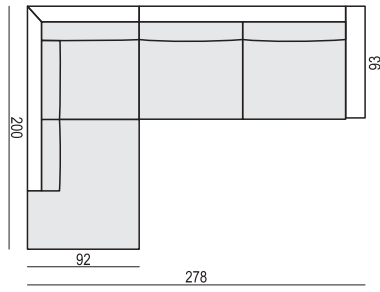

SET 13 LEFT (or RIGHT)
CHAISELONGUE LEFT (or RIGHT) + 2 SEATER RIGHT (or LEFT)

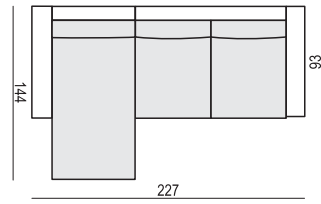

UPHOLSTERY **FABRIC: FC - fix cover**

FEET

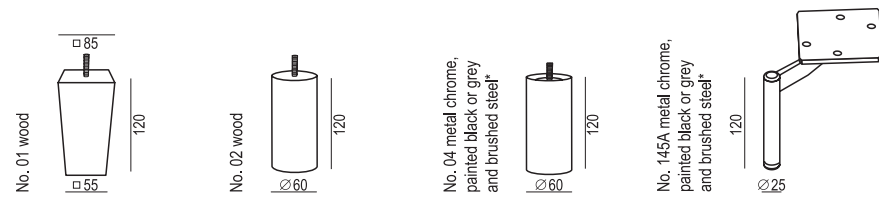

*please check a cost of brushed steel finish with a sale representative

STANDARD COMFORT

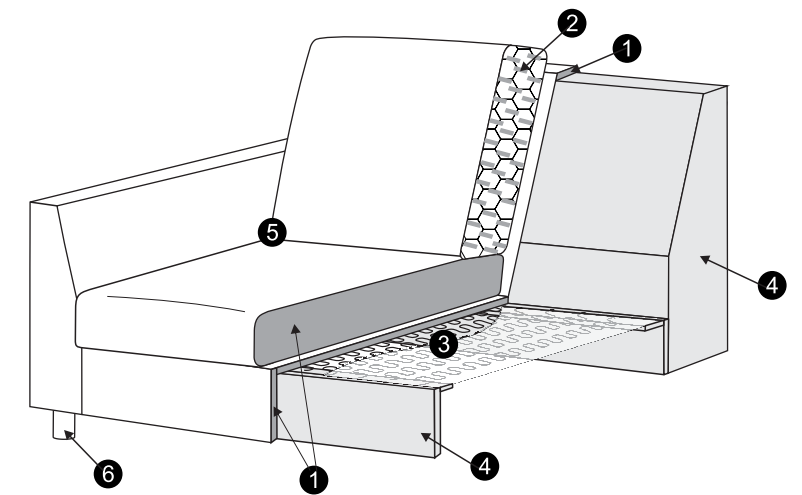

1. polyurethane foam/high resilient polyurethane foam
2. foam flakes with silicone balls
3. springs
4. FSC certified solid wood and wood based elements
5. fabric
6. FSC certified solid wood or metal legs

LUX COMFORT

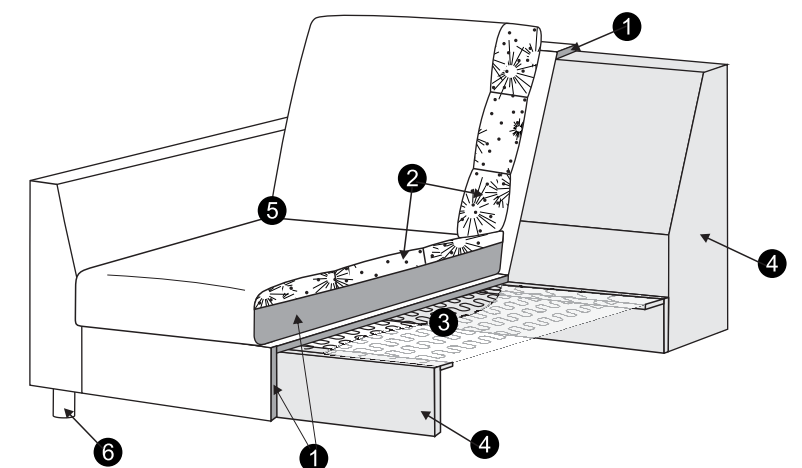

1. polyurethane foam/high resilient polyurethane foam
2. cushion chamber with mix of feather and silicone balls
3. springs
4. FSC certified solid wood and wood based elements
5. fabric
6. FSC certified solid wood or metal legs