

SITS
— *comfortable life*



cocktail
& design

AGDA

ARMCHAIR

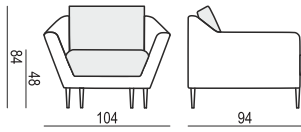

2 SEATER

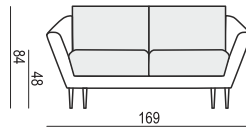

2,5 SEATER

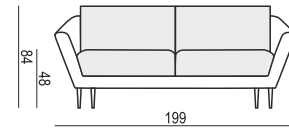

3 SEATER

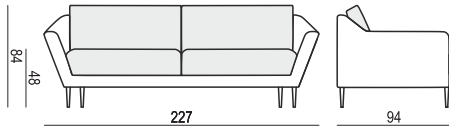

FOOTSTOOL 80x50

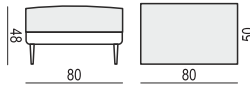

FOOTSTOOL 62x50

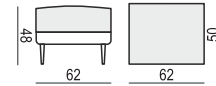

UPHOLSTERY

FABRIC: FC - fix cover

FEET

No. 128 aluminium
or aluminium painted black

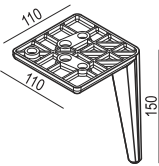

No. 145 metal chrome,
painted black or grey
and brushed steel*

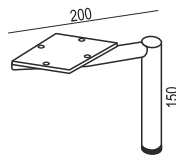

No. 141A wood
Ø32

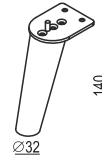

*please check a cost of brushed steel finish with a sale representative

STANDARD COMFORT

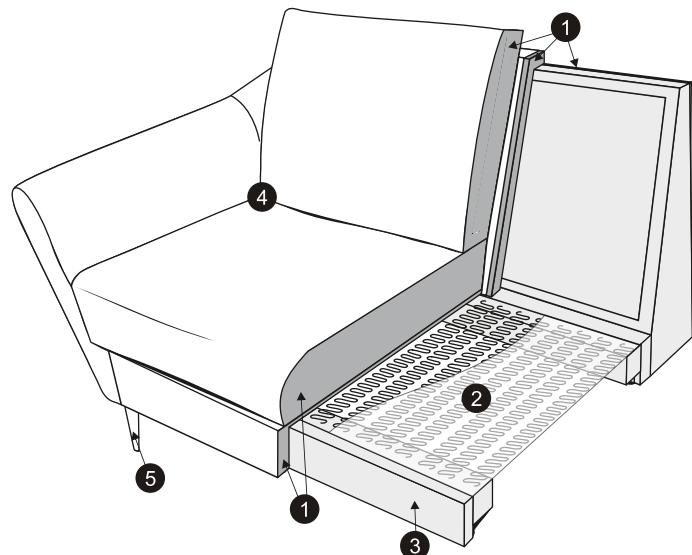

1. polyurethane foam/high resilient polyurethane foam
2. springs
3. FSC® certified solid wood and wood based elements
4. fabric
5. FSC® certified solid wood/aluminium /metal legs