

Lena

SITS



Lena

UPHOLSTERY

COMFORTS

COVERS

SPECIAL



fabric



standard



fixed



loose



modular system

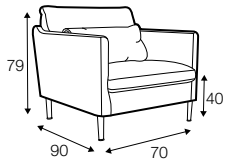

armchair

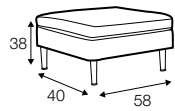

footstool 58x40
for armchair

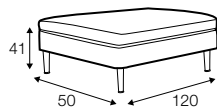

footstool 120x50

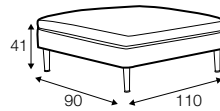

footstool 110x90

version A

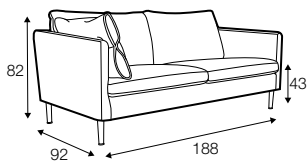

2 seater

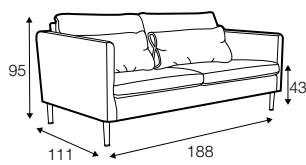

2 seater deep

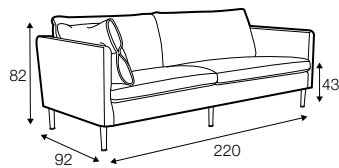

3 seater

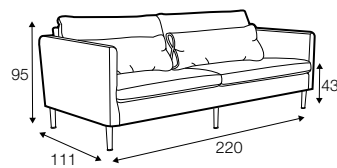

3 seater deep

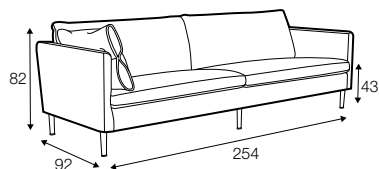

set 1
element left + element right

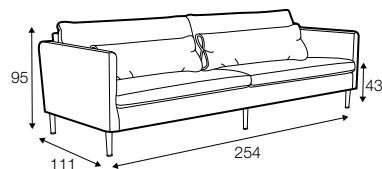

set 2 deep
element deep left + element deep right

version C

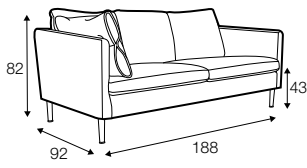

2 seater

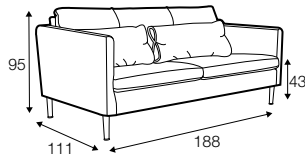

2 seater deep

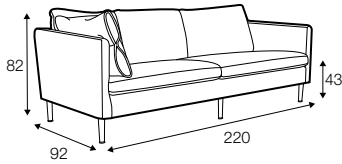

3 seater

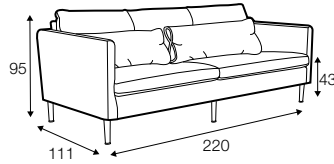

3 seater deep

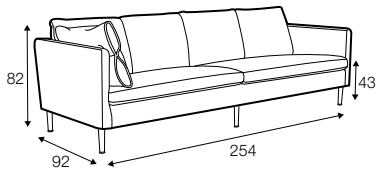

set 1
element left + element right

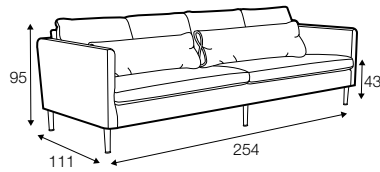

set 2 deep
element deep left + element deep right

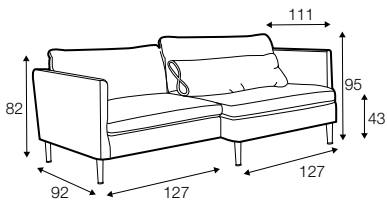

example of LENA + LENA deep
option for connecting elements

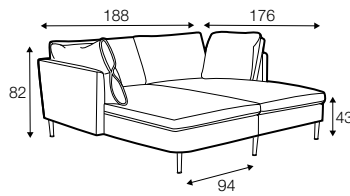

example
chaiselongue left + chaiselongue right

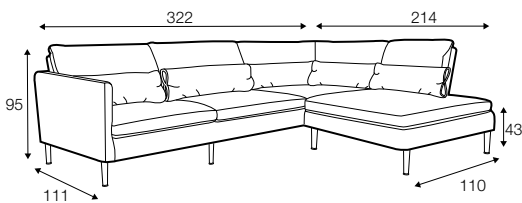

example
3 seater deep left / or right + corner deep 90° + bench deep right / or left

modular system

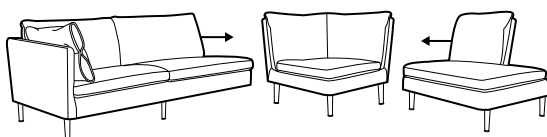

elements of the modular system version A

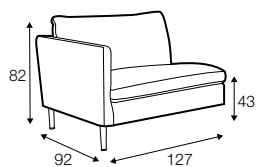

element
left / or right

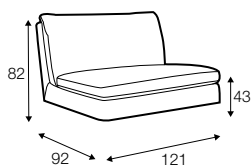

element
without armrests

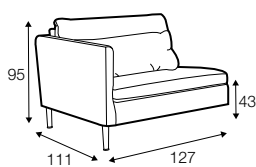

element deep
left / or right

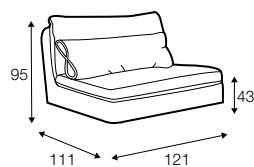

element deep
without armrests

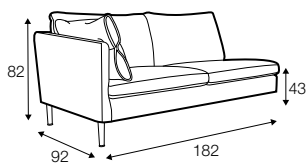

2 seater
left / or right

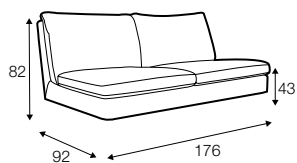

2 seater
without armrests

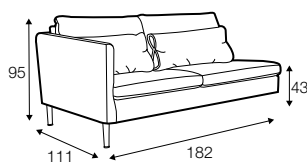

2 seater deep
left / or right

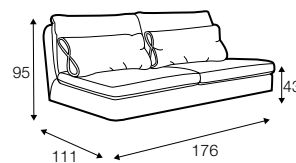

2 seater deep
without armrests

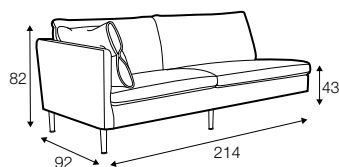

3 seater
left / or right

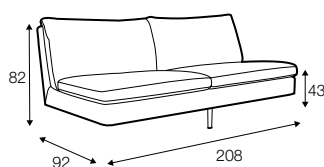

3 seater
without armrests

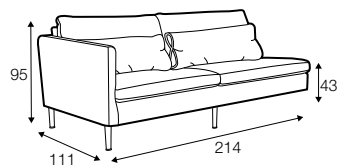

3 seater deep
left / or right

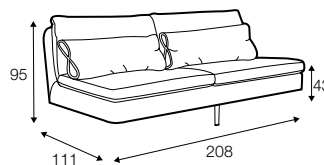

3 seater deep
without armrests

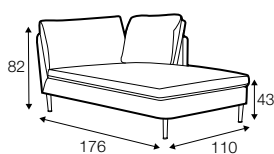

chaiselongue wide
right / or left A

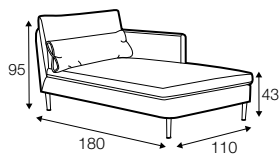

chaiselongue wide deep
right / or left A

elements of the modular system version C

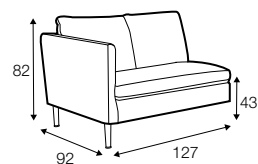

element
left / or right

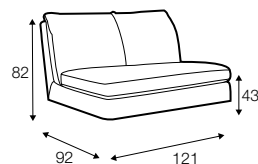

element
without armrests

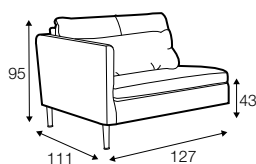

element deep
left / or right

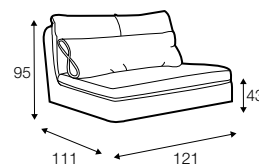

element deep
without armrests

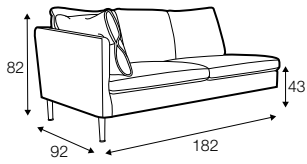

2 seater
left / or right

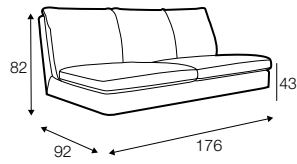

2 seater
without armrests

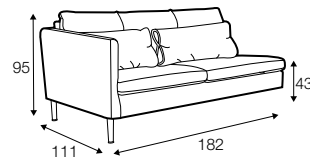

2 seater deep
left / or right

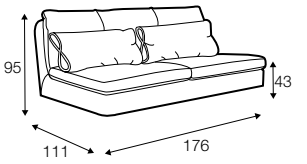

2 seater deep
without armrests

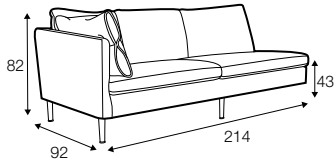

3 seater
left / or right

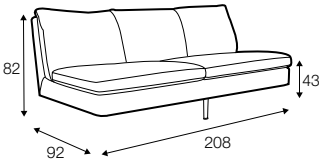

3 seater
without armrests

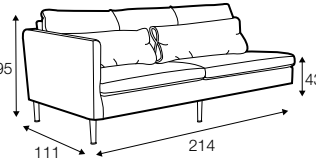

3 seater deep
left / or right

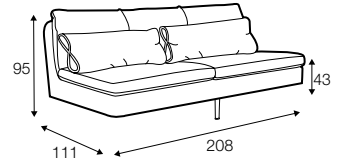

3 seater deep
without armrests

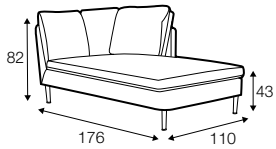

chaiselongue wide
right / or left C

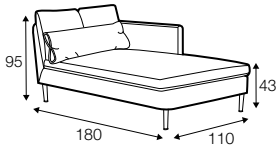

chaiselongue wide deep
right / or left C

elements of the modular system version A and C

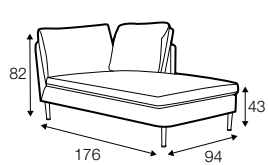

chaiselongue
right / or left

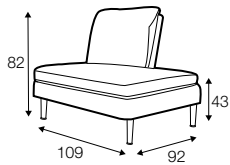

bench right / or left

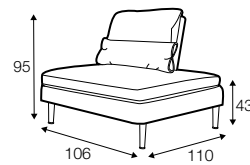

bench deep right / or left

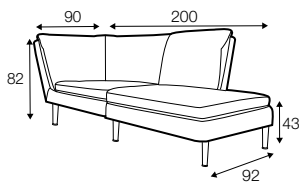

divan divided
right / or left

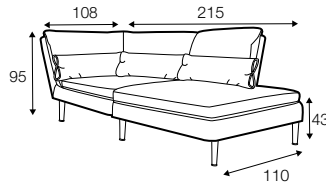

divan divided deep
right / or left

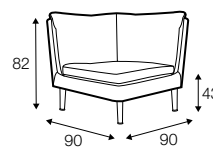

corner 90°

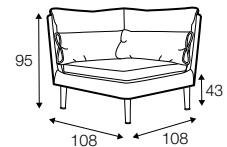

corner deep 90°

extra dimensions

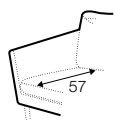

depth of armchair
and standard seat



depth of deep seat

accessories

low back cushions



cushion 58x38
divan
corner
bench

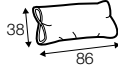

cushion 86x38
2 seater

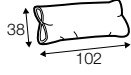

cushion 102x38
3 seater
chaiselongue

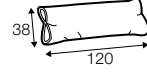

cushion 120x38
element



cushion 60x35
armchair

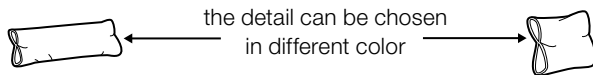

low back cushion
element deep

armrests cushion

legs

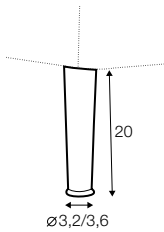

no. 161
wood
footstool 120x50,
footstool 110x90,
sofa, chaiselongue,
divan, corner 90°,
bench

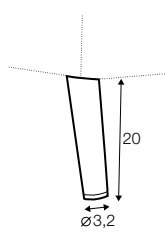

no. 163
wood
footstool 58X40,
armchair:
163 front,
163A back

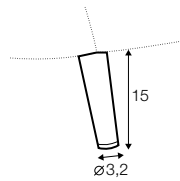

no. 163A
wood
back
armchair:
163 front,
163A back

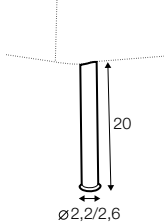

no. 162
metal chrome,
painted black or grey
and brushed steel
footstool 120x50,
footstool 110x90,
footstool 58X40,
sofa, chaiselongue,
divan, corner 90°,
bench

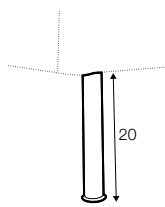

no. 150B
metal chrome,
painted black or grey
and brushed steel
front
armchair:
150B front,
160A back

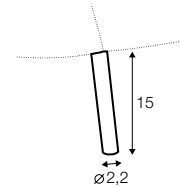

no. 160A
metal chrome,
painted black or grey
and brushed steel
back
armchair:
150B front,
160A back

profile

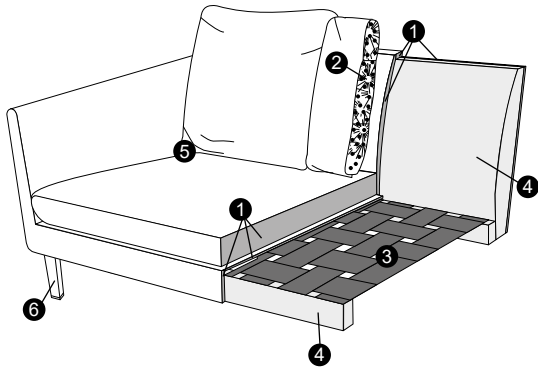

standard

1. polyurethane foam/high resilient polyurethane foam
2. cushion chamber with mix of feather and silicone balls
3. upholstery belts
4. FSC® certified solid wood frame
5. fabric
6. FSC® certified solid wood or metal legs