

# Ronja

SITS



# Ronja

## UPHOLSTERY COMFORTS



fabric



STD standard



LUX lux



FC fixed



LCV loose with velcro



modular system

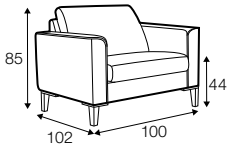

armchair

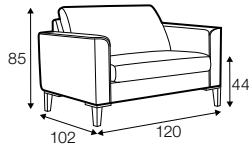

armchair wide

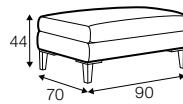

footstool 90x70

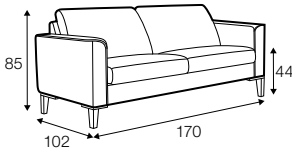

2 seater

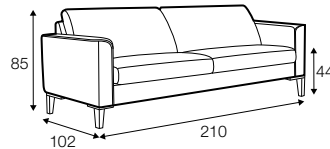

3 seater

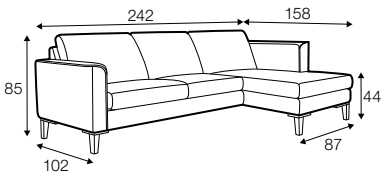

set 1 right / or left

2 seater right / or left  
+ chaiselongue left / or right

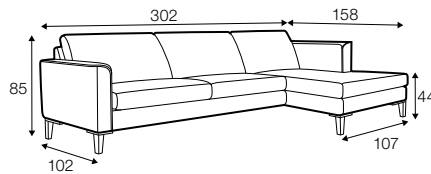

set 2 right / or left

3 seater right / or left  
+ chaiselongue wide left / or right

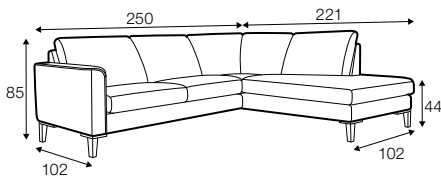

set 3 right / or left

2 seater right / or left + divan left / or right

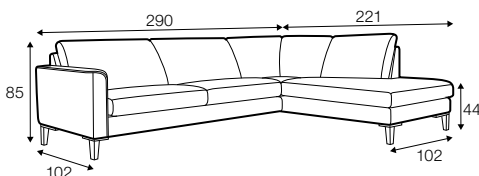

set 4 right / or left

3 seater right / or left + divan left / or right

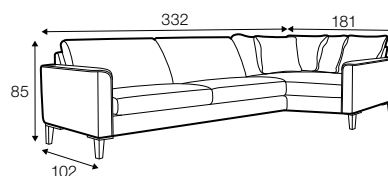

set 5 left / or right

cozy corner left / or right + 3 seater right / or left

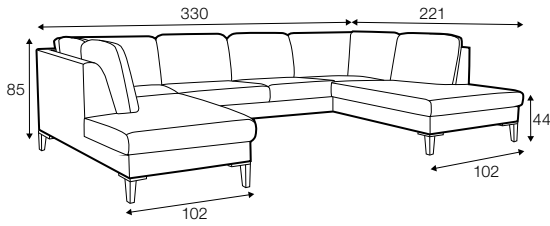

set 6  
divan left / or right + 2 seater without armrest  
+ divan right / or left

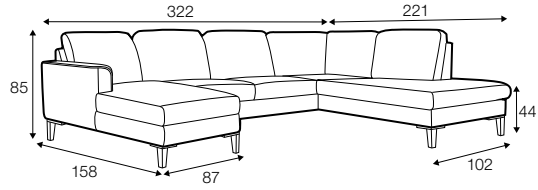

set 7 left / or right  
chaiselongue left / or right + 2 seater without armrest  
+ divan right / or left

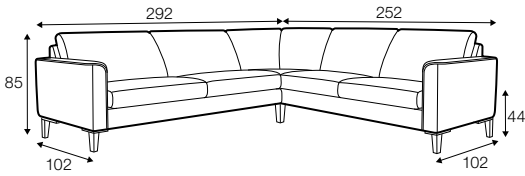

set 8 right / or left  
3 seater left + corner 90° no. 1 + 2 seater right

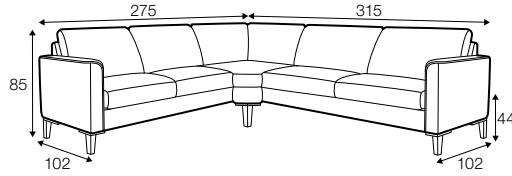

set 9 left / or right  
2 seater left / or right + corner 90° no. 2  
+ 3 seater right / or left

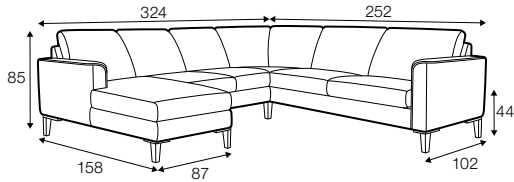

set 10 left / or right  
chaiselongue left / or right + 2 seater without armrest  
+ corner 90° no. 1 + 2 seater right / or left

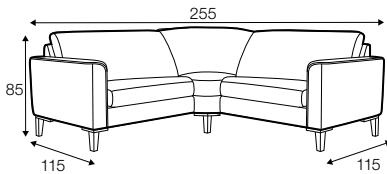

set 13  
armchair left + corner 30°  
+ armchair right

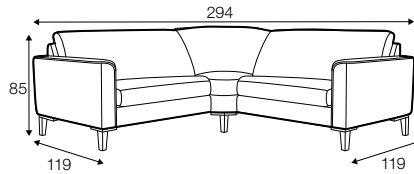

set 14  
armchair wide left + corner 30°  
+ armchair wide right

**modular system**

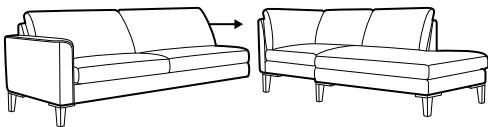

**elements of the modular system**

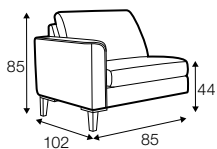

armchair  
left / or right

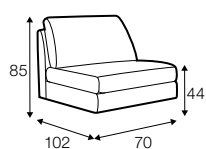

armchair  
without armrests

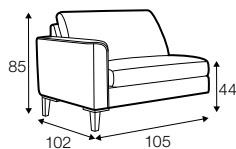

armchair wide  
left / or right

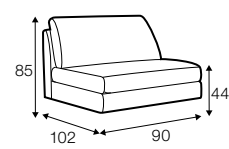

armchair wide  
without armrests

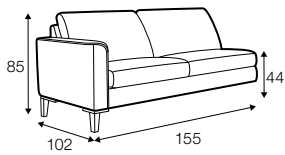

2 seater left / or right

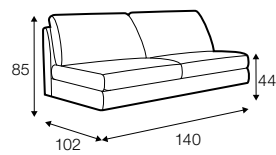

2 seater without armrests

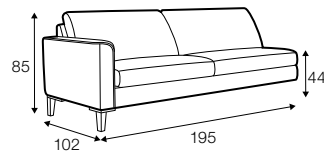

3 seater left / or right

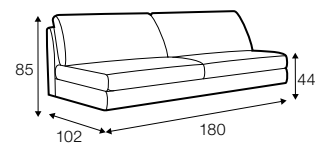

3 seater without armrests

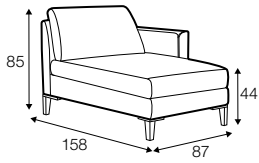

chaiselongue right / or left

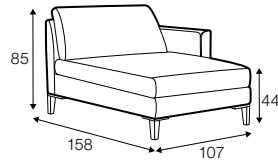

chaiselongue wide right / or left

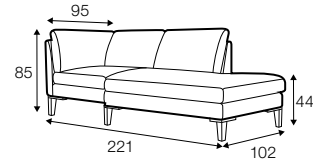

divan right / or left

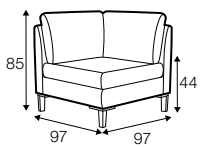

corner 90° no. 1

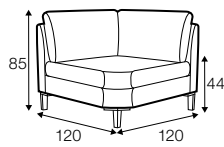

corner 90° no. 2

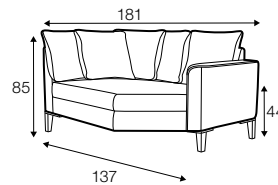

cozy corner right / or left

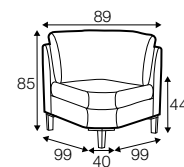

corner 30°

## extra dimensions

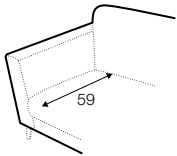

depth of seat

## accessories

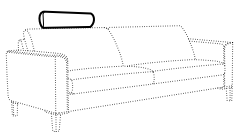

headrest L-62

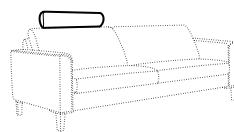
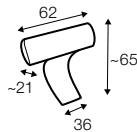

headrest L-77

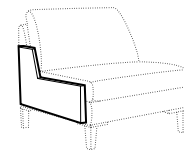
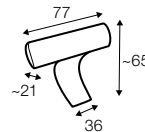

endpart left / or right

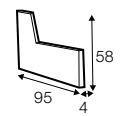

## legs

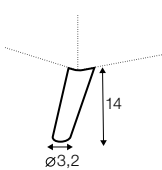

no. 141A  
wood  
recommended

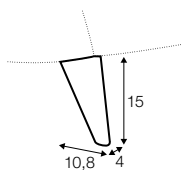

no. 91  
wood

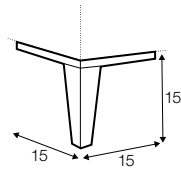

no. 152  
wood

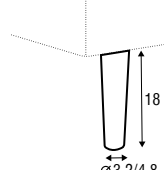

no. 141B  
wood

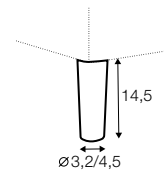

no. 153  
wood

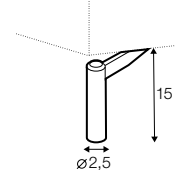

no. 145A  
metal chrome,  
painted black or grey  
and brushed steel\*

\*please check a cost of brushed steel finish with a sale representative.

## profile

---

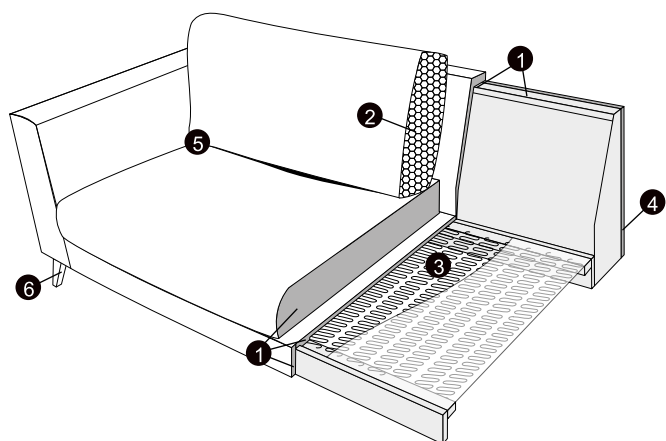

### standart

1. polyurethane foam/ high resilient polyurethane foam
2. silicone balls
3. springs
4. FSC certified solid wood and wood based elements
5. fabric
6. FSC certified solid wood or metal legs

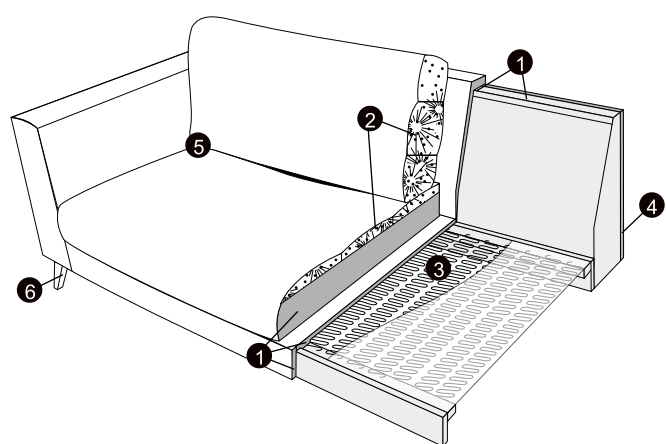

### lux

1. polyurethane foam/ high resilient polyurethane foam
2. cushion chamber with mix of feather and silicone balls
3. springs
4. FSC certified solid wood and wood based elements
5. fabric
6. FSC certified solid wood or metal legs