

Elis

SiTS



# Elis

## UPHOLSTERY



fabric

## COMFORTS



standard



lux



classic

## COVERS



fixed



loose

## SPECIAL



modular system

Drawing show combinations with armrest A. Combinantons with other armrest are properly longer or shorter in width.

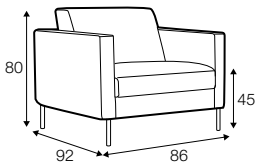

armchair

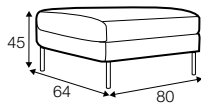

footstool 80x64

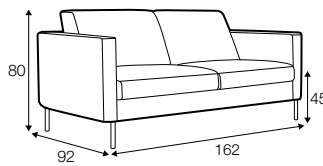

2 seater

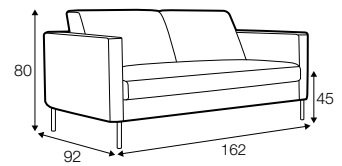

2 seater  
with 1 cushion

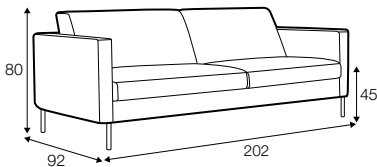

3 seater

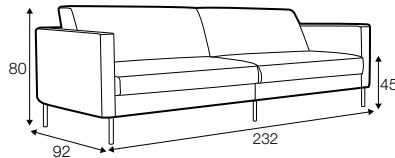

3,5 seater divided  
with 2 cushions

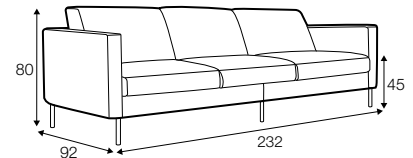

3,5 seater divided  
with 3 cushions

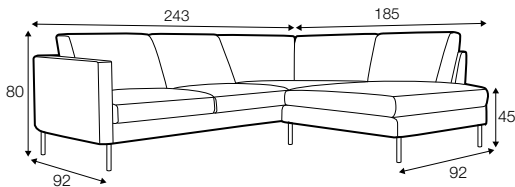

set 1 right / or left  
2 seater left / or right + divan right / or left

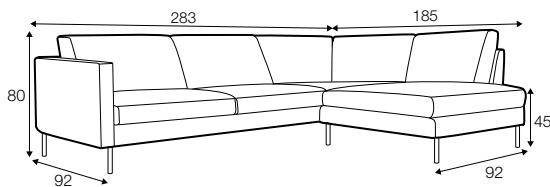

set 2 right / or left  
3 seater left / or right + divan right / or left

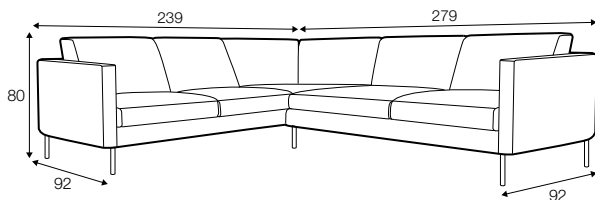

set 3 left / or right  
2 seater left / or right + corner 90° + 3 seater right / or left

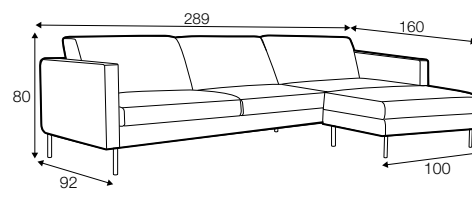

set 4 right / or left  
3 seater left / or right + chaiselongue right / or left

## modular system

---

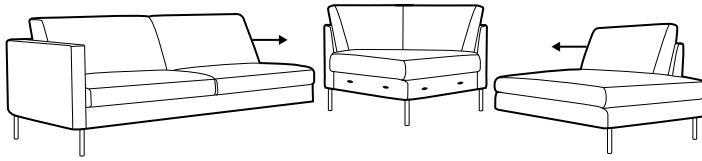

## elements of the modular system

---

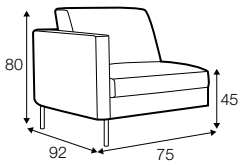

armchair left / or right

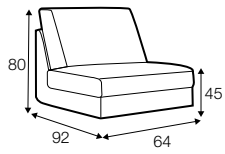

armchair  
without armrests

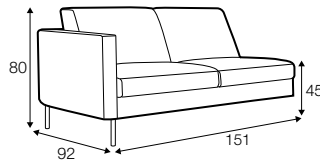

2 seater left / or right

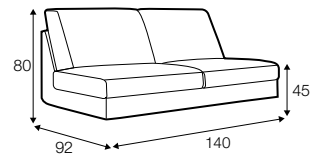

2 seater without armrests

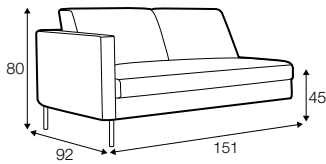

2 seater left / or right  
with 1 cushion

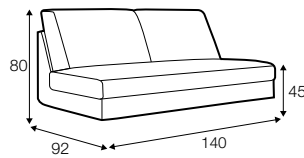

2 seater without armrests  
with 1 cushion

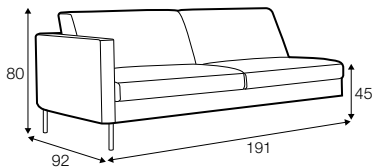

3 seater left / or right

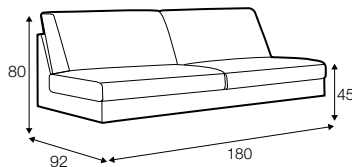

3 seater without armrests

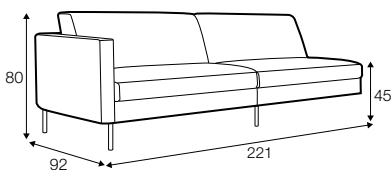

3,5 seater divided left / or right  
with 2 cushions

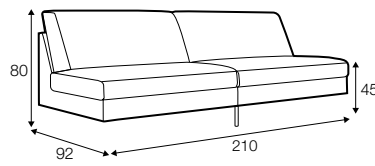

3,5 seater divided without armrests  
with 2 cushions

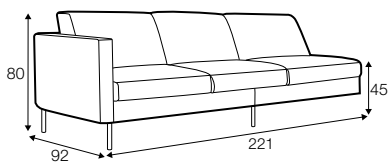

3,5 seater divided left / or right  
with 3 cushions

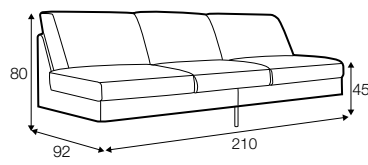

3,5 seater divided without armrests  
with 3 cushions

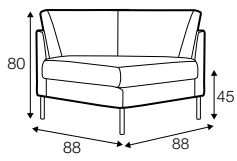

corner 90°

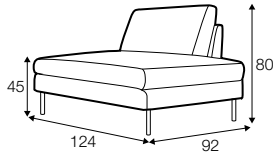

bench right / or left

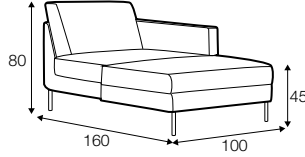

chaiselongue right / or left

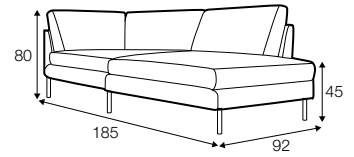

divan right / or left

## extra dimensions

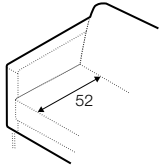

depth of seat

## accessories

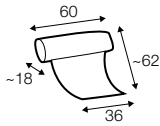
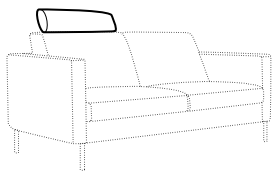

headrest L-60

recommended for armchair, 2 seater  
3,5 seater with 3 seat cushions, bench,  
corner, divan

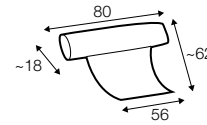
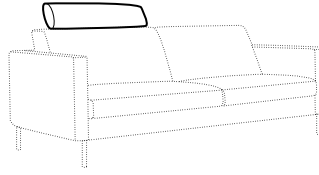

headrest L-80

recommended for 3 seater, divan

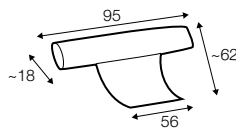
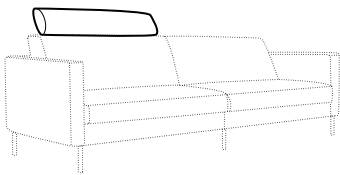

headrest L-95

recommended for 3,5 seater with 2 seat cushions

Headrest with french stitching are recommended form armrests A/B.  
Headrest without french stitching are recommended form armrests C/D.

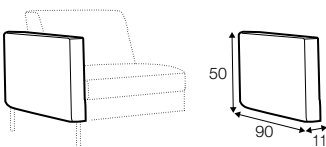

armrest A

french stitching on armrest  
and back cushions

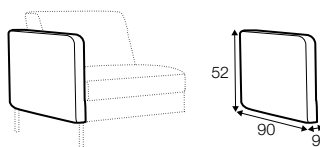

armrest B

french stitching on armrest  
and back cushions

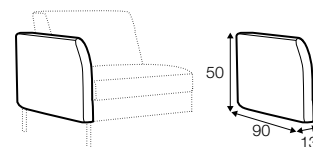

armrest C

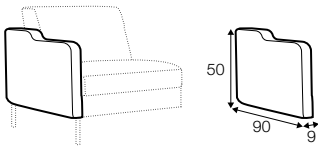

armrest D

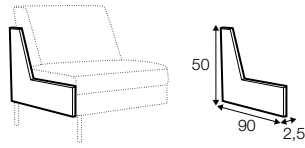

endpart left / or right

## legs

---

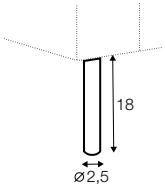

no. 177  
metal painted black,  
grey or white  
recommended

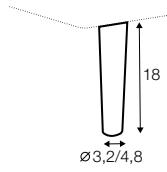

no. 141  
wood

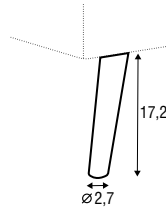

no. 154A  
wood

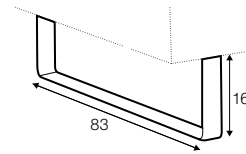

no. 104  
metal painted black,  
grey or white

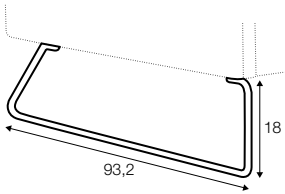

no. 179  
metal painted black,  
grey or white

## There are two options to place the leg.

---

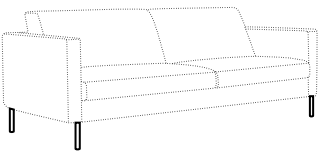

under armrest

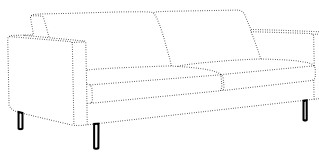

under frame

## profile

---

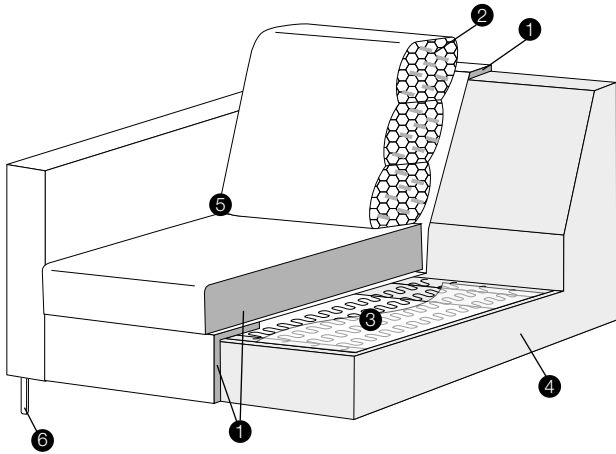

### standard

1. polyurethane foam/ high resilient polyurethane foam
2. foam flakes with silicone balls
3. springs
4. FSC® certified solid wood and wood based elements
5. fabric
6. FSC® certified solid wood or metal legs

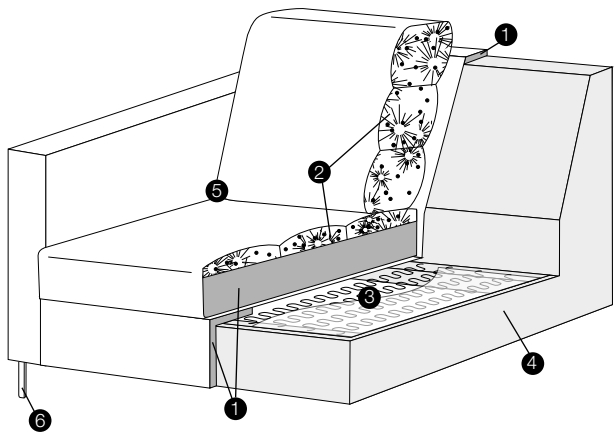

### lux

1. polyurethane foam/ high resilient polyurethane foam
2. cushion chamber with mix of feather and silicone balls
3. springs
4. FSC® certified solid wood and wood based elements
5. fabric
6. FSC® certified solid wood or metal legs

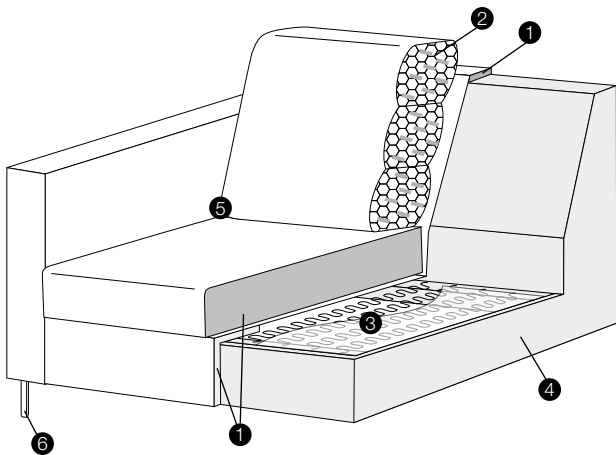

### classic

1. polyurethane foam/ high resilient polyurethane foam
2. foam flakes with silicone balls
3. springs
4. FSC® certified solid wood and wood based elements
5. fabric
6. FSC® certified solid wood or metal legs