

# Felix

# SITS



# Felix

UPHOLSTERY

COMFORTS

COVERS



fabric



STD standard



FC fixed

All drawings shown height with leg no. 111E H-15.  
Two mattresses available: bonell and foam.

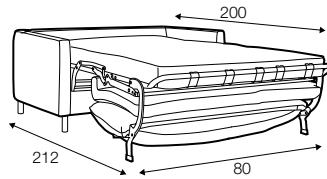
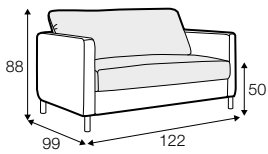

armchair sofa bed

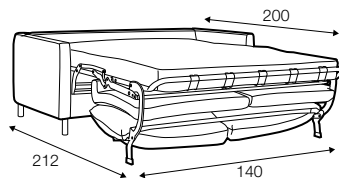
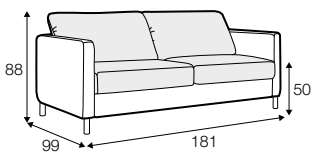

3 seater sofa bed

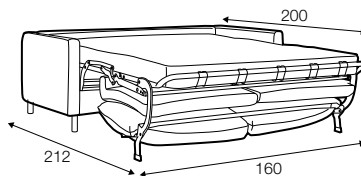
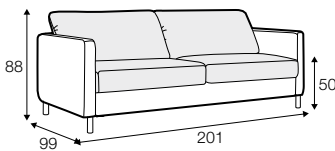

4 seater sofa bed

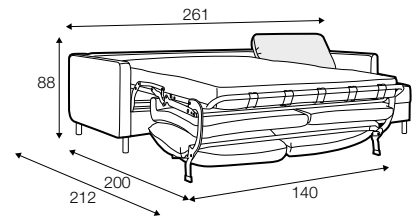
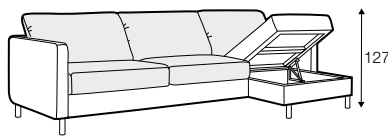
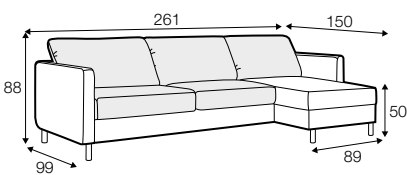

set 1 right / or left

3 seater sofa bed left / or right + chaiselongue box right / or left

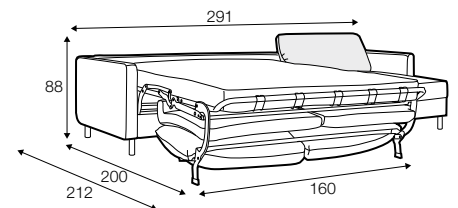
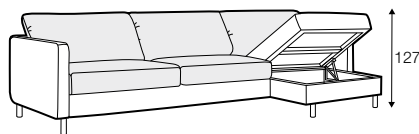
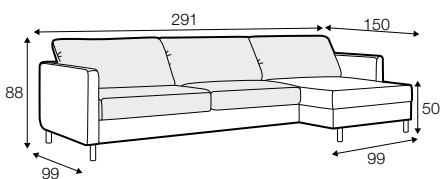

set 2 right / or left

4 seater sofa bed left / or right + chaiselongue box right / or left

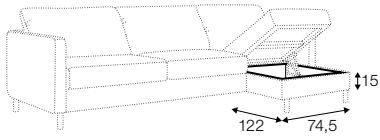

box dimensions  
set 1

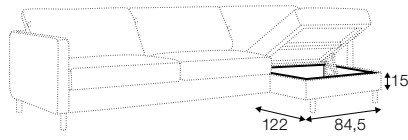

box dimensions  
set 2

## extra dimensions

---

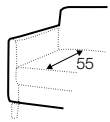

depth of seat

## accessories

---

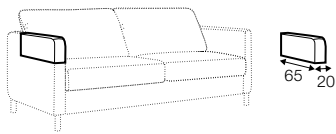

armrest protection

## legs

---

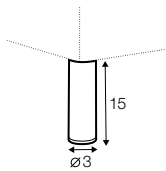

no. 111E  
metal chrome,  
painted black or grey  
and brushed steel\*

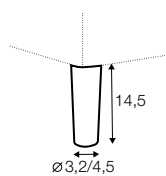

no. 153A  
wood

## profile

---

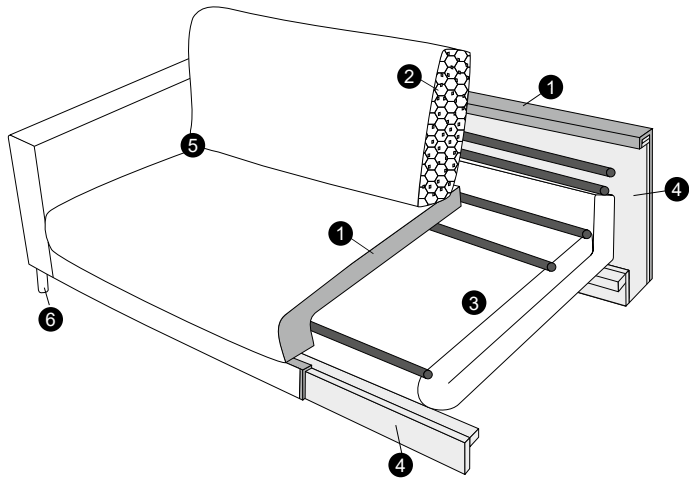

### standard

1. polyurethane foam / high resilient polyurethane foam
2. foam flakes with silicone balls
3. bonnell / foam mattress
4. FSC® certified solid wood and wood based elements
5. fabric
6. solid wood / metal legs