

Sally

SITS



Sally

UPHOLSTERY

COMFORTS

COVERS

SPECIAL



fabric



standard



classic



loose



loose with velcro



modular system

Drawing show combinations with armrest II. Combinantons with other armrest are properly longer or shorter in width.
All elements in loose cover with velcro are with french stitching on the armrest.

loose cover elements

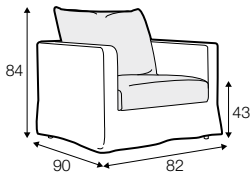

armchair

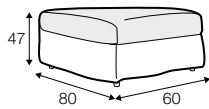

footstool 80x60

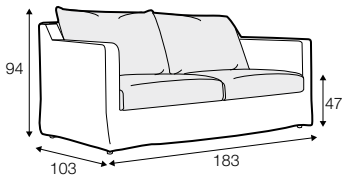

2 seater

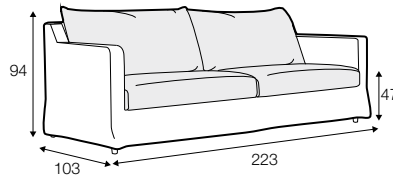

3 seater

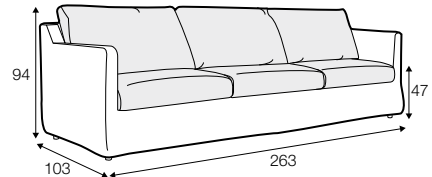

3XL seater divided

loose cover elements with velcro

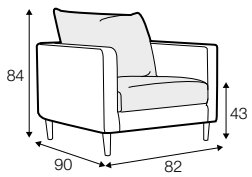

armchair

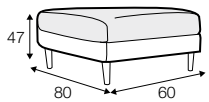

footstool 80x60

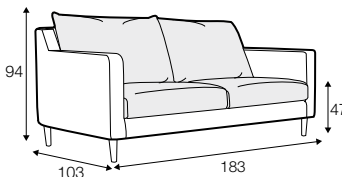

2 seater

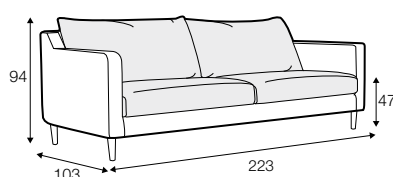

3 seater

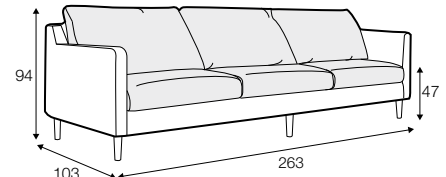

3XL seater divided

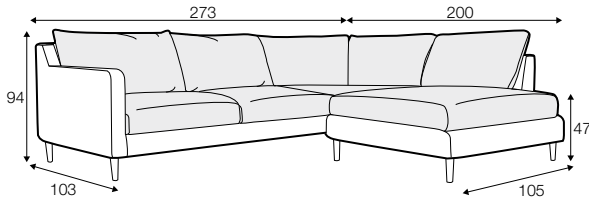

set 1 right
2 seater left / or right + divan right / or left

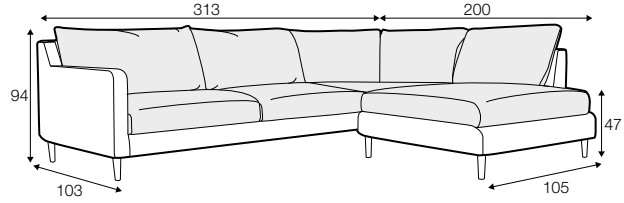

set 2 right
3 seater left / or right + divan right / or left

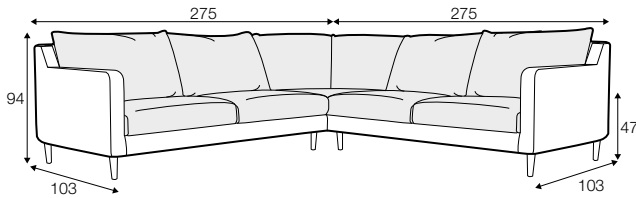

set 3
2 seater left / or right + corner 90° + 2 seater right / or left

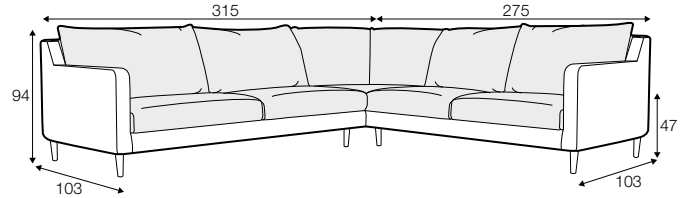

set 4 right
2 seater right/ or left + corner 90 + 3 seater left/or right

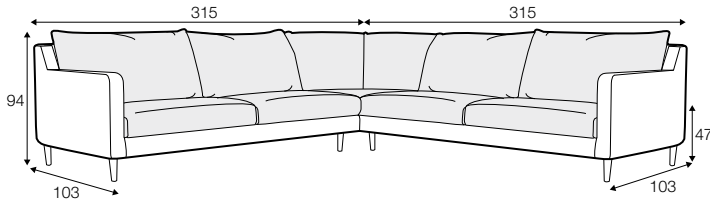

set 5
3 seater left / or right + corner 90° + 3 seater right / or left

modular system

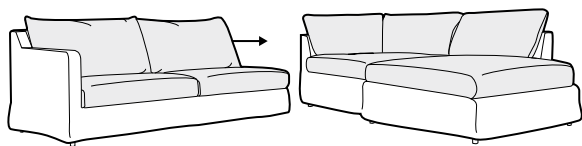

elements of the modular system loose cover elements

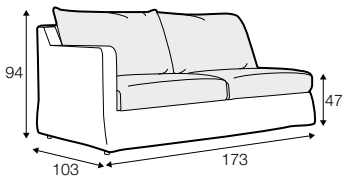

2 seater left / or right

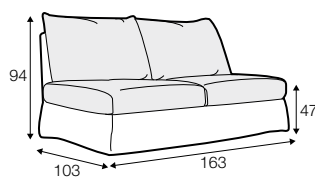

2 seater without armrests

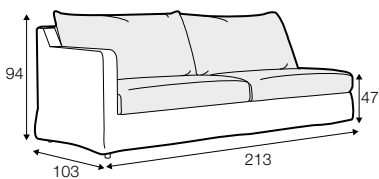

3 seater left / or right

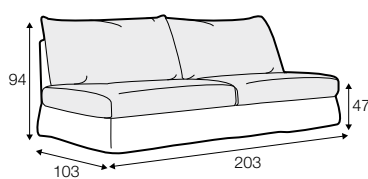

3 seater without armrests

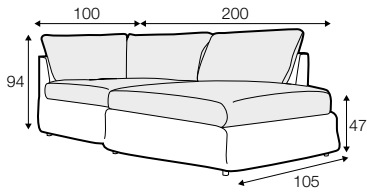

divan right / or left

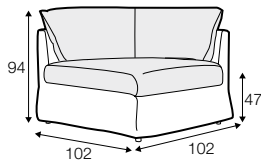

corner 90°

loose cover elements with velcro

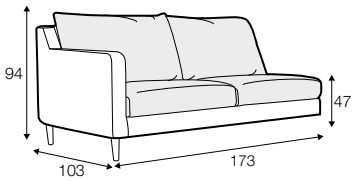

2 seater left / or right

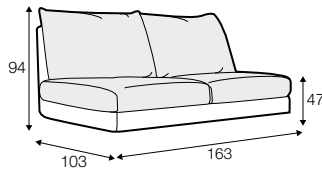

2 seater without armrests

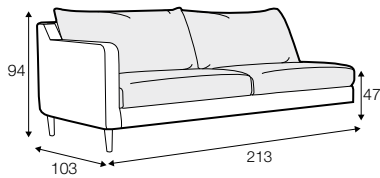

3 seater left / or right

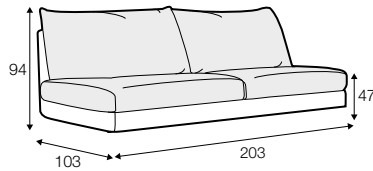

3 seater without armrests

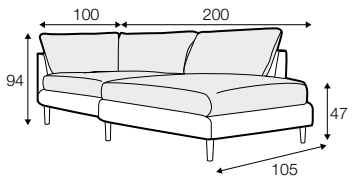

divan right / or left

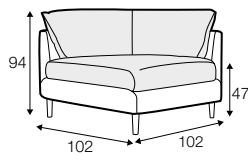

corner 90°

extra dimensions

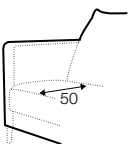

depth of armchair seat

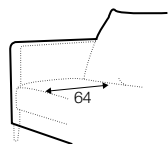

depth of sofa seat

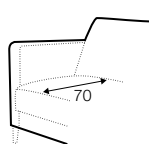

depth of armchair seat without cushions

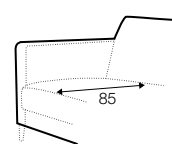

depth of sofa seat without cushions

accessories

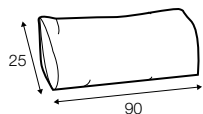

lumbar cushion 90x25
cushion: 3 seater

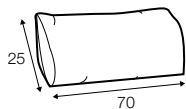

lumbar cushion 70x25
cushion: 2 seater, 3XL seater

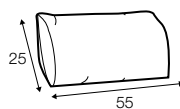

lumbar cushion 55x25
cushion: divan, corner 90°

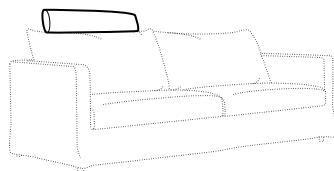

headrest L-90

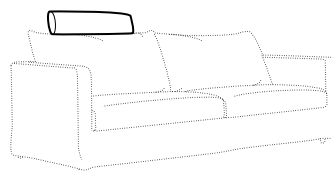
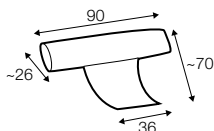

headrest L-80

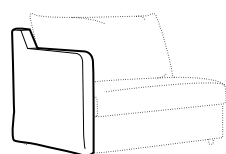
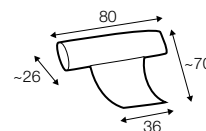

armrest I

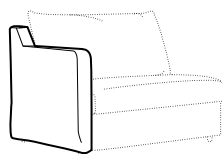
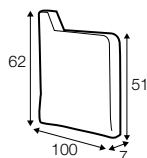

armrest II

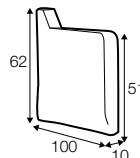

legs

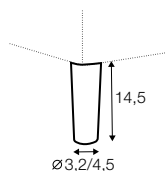

no. 153
wood

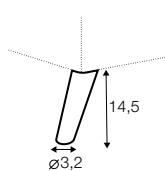

no. 141A
wood
back: only for armchair
with leg no. 153

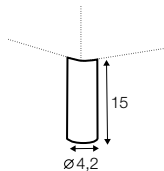

no. 174
wood

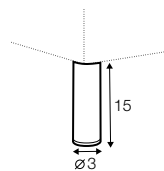

no. 111D
metal chrome,
painted black or grey
and brushed steel*

*please check a cost of brushed steel finish with a sale representative

profile

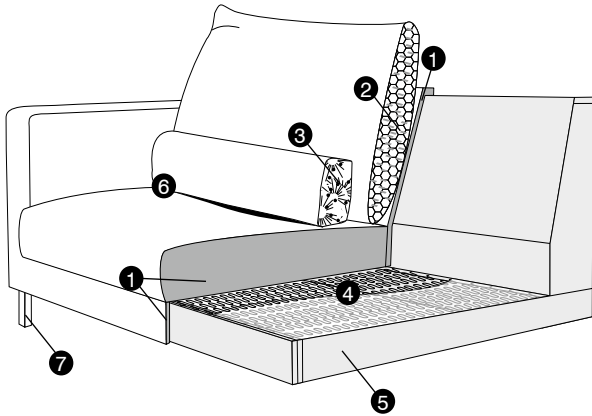

standard

1. polyurethane foam/ high resilient polyurethane foam
2. cushion chamber with mix of foam flakes and silicone balls
3. cushion chamber with mix of feather and silicone balls
4. springs
5. FSC® certified solid wood and wood based elements
6. fabric
7. FSC® certified solid wood or metal legs

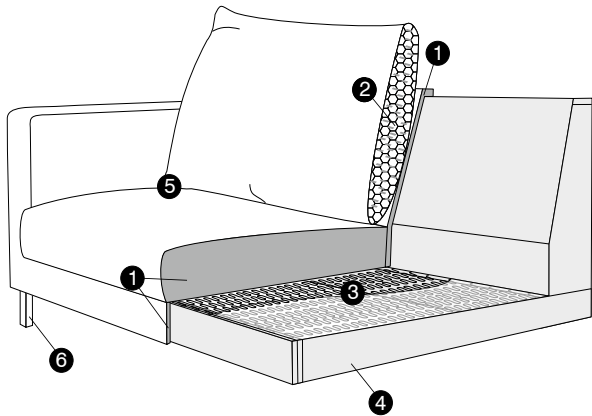

classic

1. polyurethane foam/high resilient polyurethane foam
2. cushion chamber with mix of foam flakes and silicone balls
3. springs
4. FSC® certified solid wood and wood based elements
5. fabric
6. FSC® certified solid wood or metal legs