

Alva

SITS



Alva

UPHOLSTERY

COMFORTS

COVERS

SPECIAL



fabric



STD standard



CLS classic



FC fixed



modular system

All elements available also as freestanding elements.

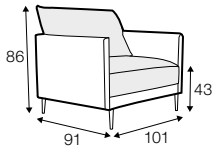

armchair

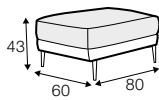

footstool 60x80

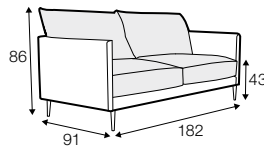

2 seater

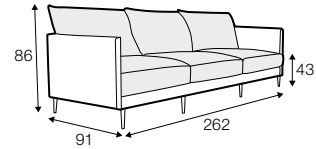

3 seater

seat elements

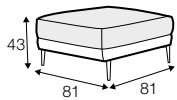

seat element 80

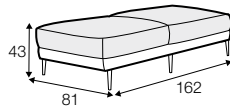

seat element 160

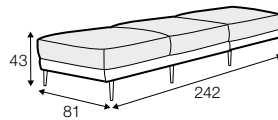

seat element 240

unlimited possibilities of combinations - below example arrangements

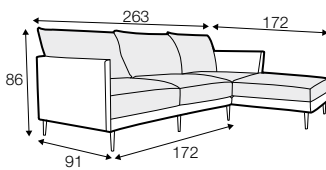

2x seat element 160
+ 5x armrests
+ 3x cushion 81

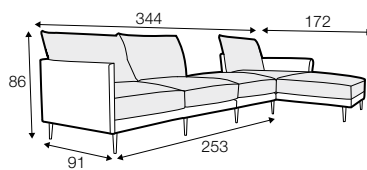

2x seat element 160
+ seat element 80
+ 5x armrests
+ 3x cushion 81

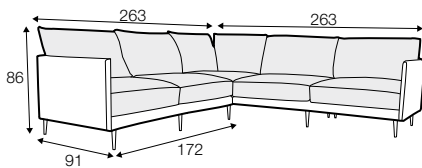

2x seat element 160
+ seat element 80
+ 8x armrests
+ 5x cushion 81
+ cushion 67

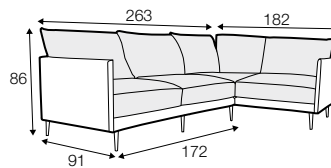

seat element 160
+ 2x seat element 80
+ 7x armrests
+ 4x cushion 81
+ cushion 67

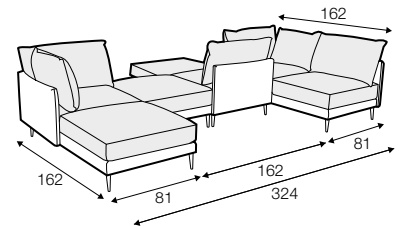

3x seat element 160
+ seat element 80
+ 6x armrests
+ 2x cushion 67
+ 4x cushion 81

extra dimensions

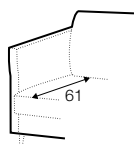

depth of seat

accessories

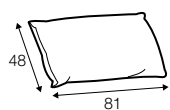

cushion 81x48

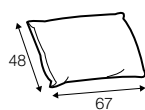

cushion 67x48

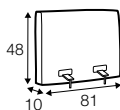

armrest/backrest
available in loose cover

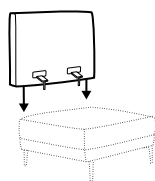

legs

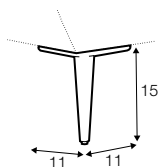

no. 128
aluminium
or aluminium
painted black

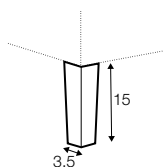

no. 109
wood

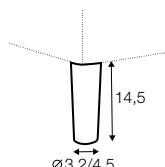

no. 153
wood

profile

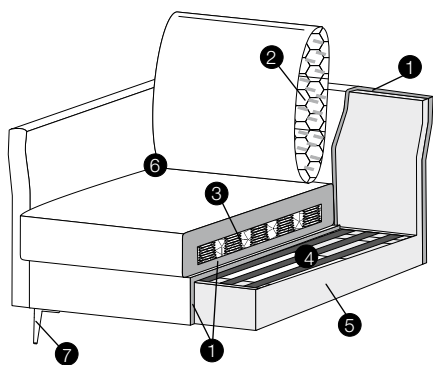

standard

1. polyurethane/laminated foam
2. foam flakes with silicone balls
3. bonnell springs
4. upholstery belts
5. solid wood and wood based elements
6. fabric
7. solid wood or metal legs

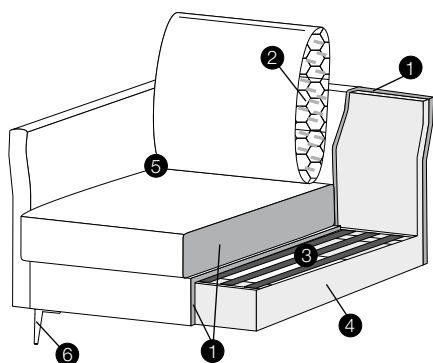

classic

1. polyurethane/laminated foam
2. foam flakes with silicone balls
3. upholstery belts
4. solid wood and wood based elements
5. fabric
6. solid wood or metal legs