

Teddy

SITS



Teddy

designed by: Steven Schilte



UPHOLSTERY



fabric

COMFORTS



STD standard



LUX lux



CLS classic

COVERS



FC fixed

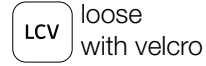

LCV loose with velcro

SPECIAL



modular system

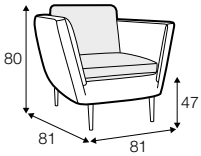

armchair

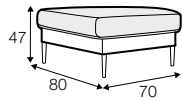

footstool 80x70

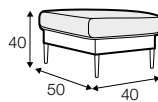

footstool 50x40
only for armchair

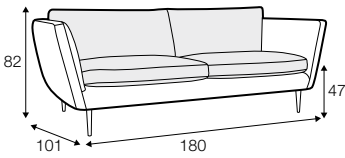

2 seater

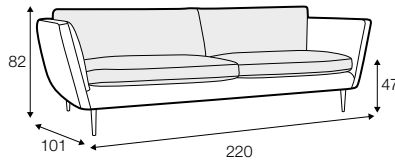

3 seater

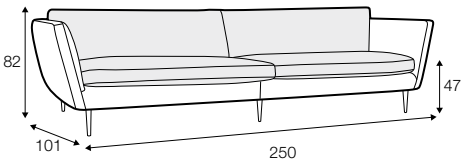

4 seater divided with two cushions

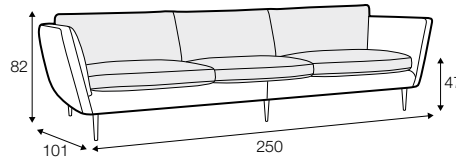

4 seater divided with three cushions

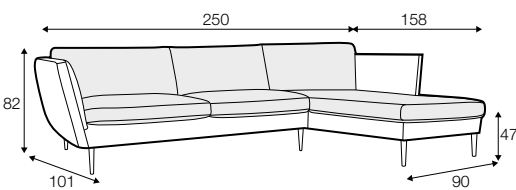

set 1 right / or left

2 seater left / or right + chaiselongue right / or left

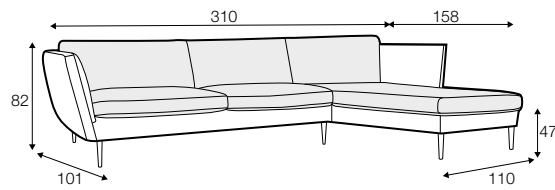

set 2 right / or left

3 seater left / or right + chaiselongue wide right / or left

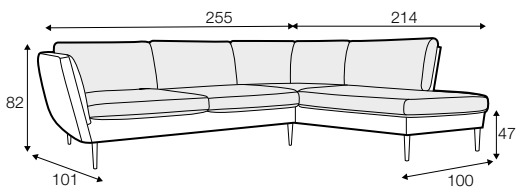

set 3 right / or left

2 seater left / or right + divan right / or left

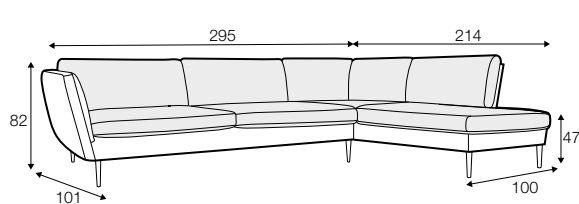

set 4 right / or left

3 seater left / or right + divan right / or left

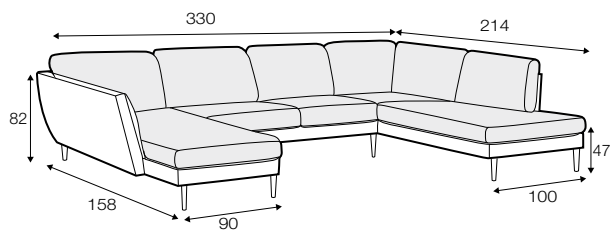

set 5 right / or left
chaiselongue left / or right + 2 seater without armrests
+ divan right/or left

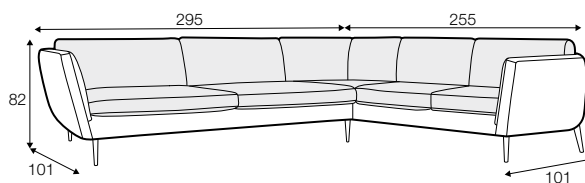

set 6 right / or left
3 seater left / or right + corner 90° + 2 seater right / or left

elements of the modular system

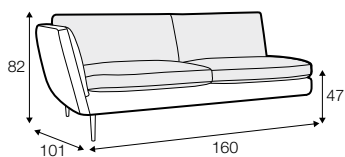

2 seater left / or right

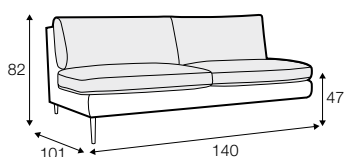

2 seater without armrests

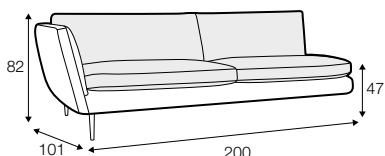

3 seater left / or right

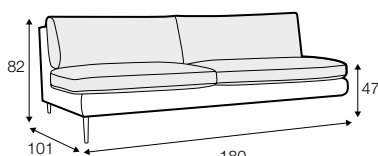

3 seater without armrests

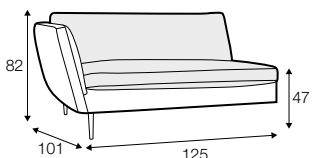

element 125 left / or right

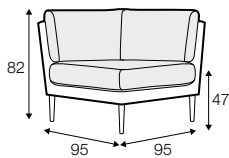

corner 90°

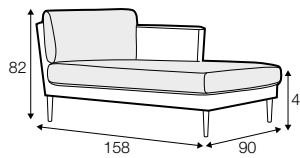

chaiselongue right / or left

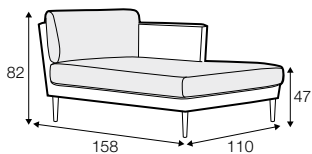

chaiselongue wide right / or left

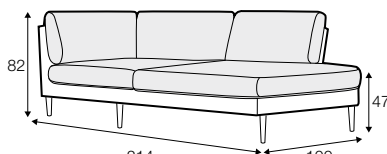

divan right / or left

extra dimensions

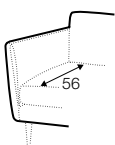

depth of sofas

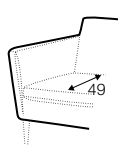

depth of armchair

accessories

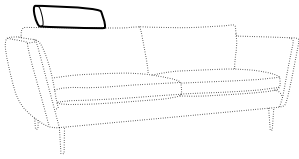

headrest L-62

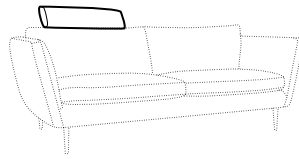
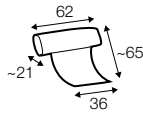

headrest L-77

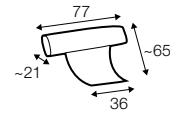

endpart left / or right

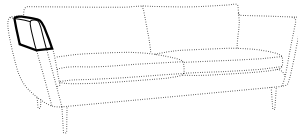
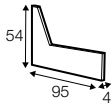

armrest protection

legs

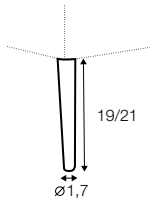

no. 186
wood

sofas H-19
footstool for armchair H-19
armchair: front H-21 back H-19
corner, divan: H-19

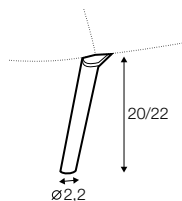

no. 160
metal chrome,
painted black

sofas H-20
footstool for armchair H-20
armchair: front H-22 back H-20
divan: front H-20 back 160A H-20
corner 160A H-20

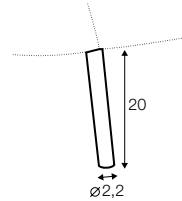

no. 160C
metal chrome,
painted black

only for divan,
corner

profile

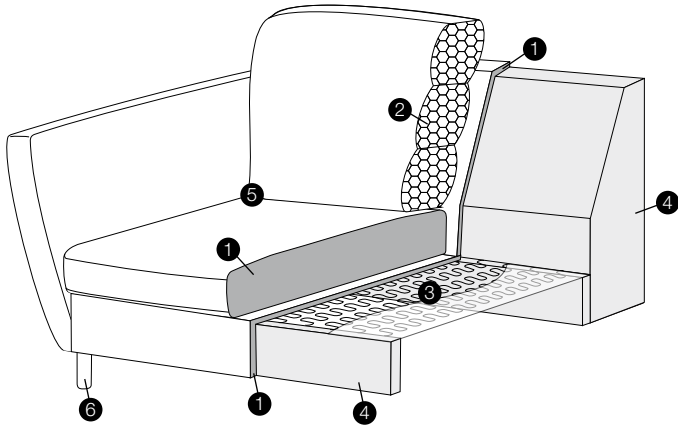

standard

1. polyurethane foam / high resilient polyurethane foam
2. silicone balls
3. springs
4. solid wood and wood based elements
5. fabric
6. solid wood or metal legs

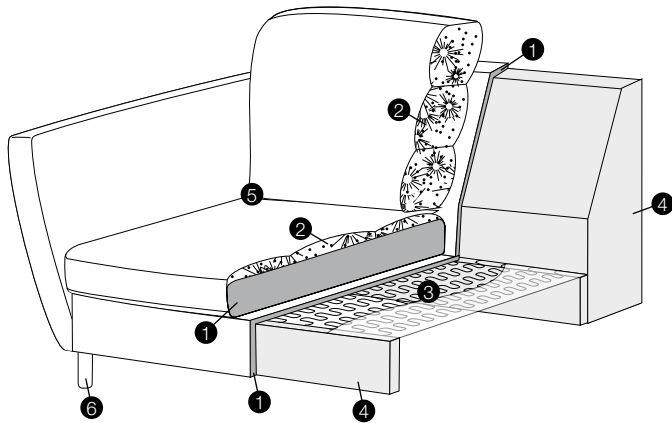

lux

1. polyurethane foam / high resilient polyurethane foam
2. cushion chamber with mix of feather and silicone balls
3. springs
4. solid wood and wood based elements
5. fabric
6. solid wood or metal legs

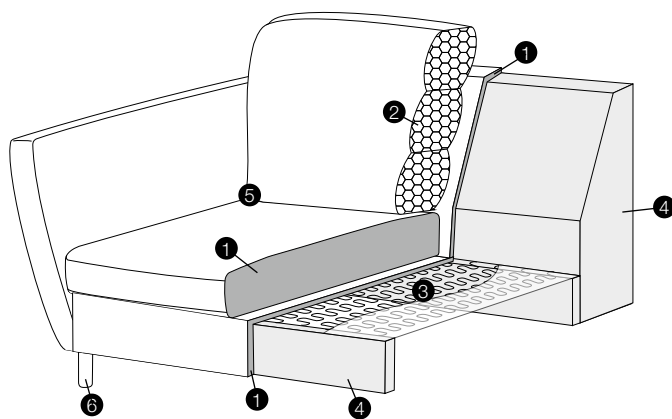

classic

1. polyurethane foam / high resilient polyurethane foam
2. silicone balls
3. springs
4. solid wood and wood based elements
5. fabric
6. solid wood or metal legs

profile

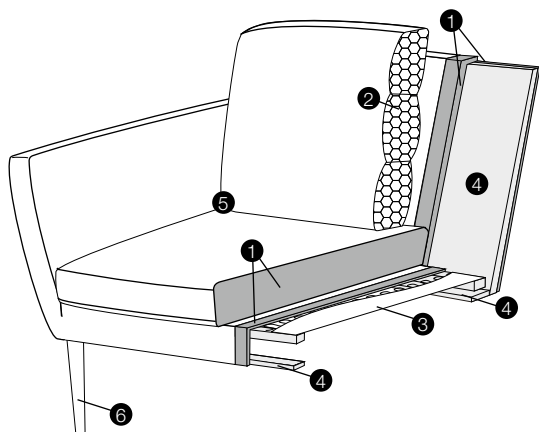

standard

1. polyurethane foam / high resilient polyurethane foam
2. silicone balls
3. springs
4. solid wood and wood based elements
5. fabric
6. solid wood/metal legs

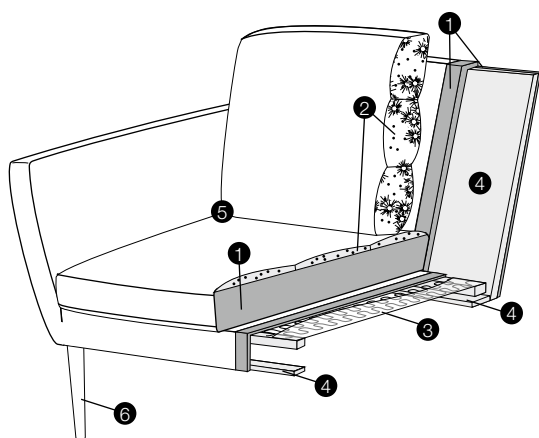

lux

1. polyurethane foam / high resilient polyurethane foam
2. cushion chamber with mix of feather and silicone balls
3. springs
4. solid wood and wood based elements
5. fabric
6. solid wood or metal legs

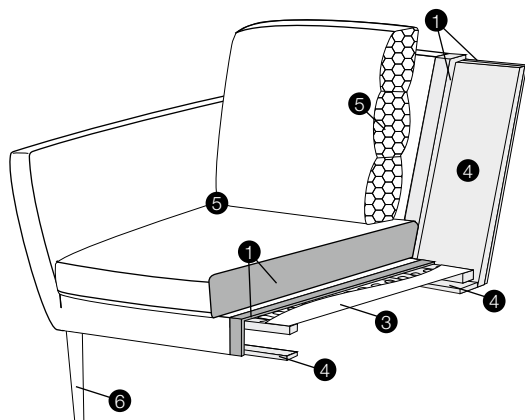

classic

1. polyurethane foam / high resilient polyurethane foam
2. silicone balls
3. springs
4. solid wood and wood based elements
5. fabric
6. solid wood or metal legs