

Karla

SITS



Karla

UPHOLSTERY COMFORTS



fabric



STD standard



LUX lux



CLS classic

COVERS



FC fixed



LCV loose with velcro

COVERS



modular system

All drawings shown height with leg no. 141A H-14.

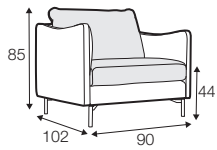

armchair

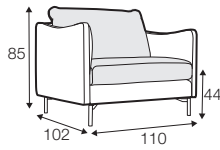

armchair wide

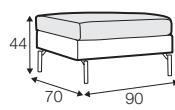

footstool 90x70

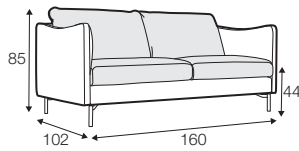

2 seater

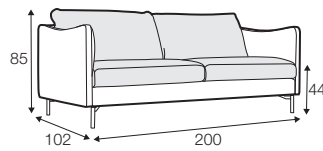

3 seater

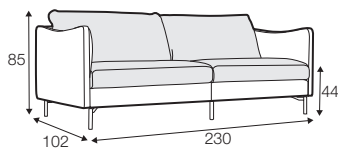

3XL seater divided
with 2 cushions

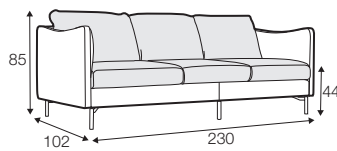

3XL seater divided
with 3 cushions

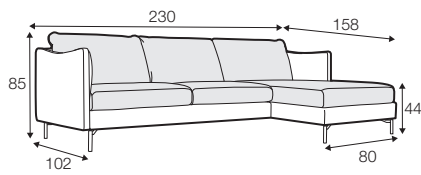

set 1 right / or left
2 seater left / or right + chaiselongue right / or left

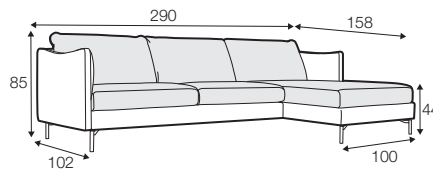

set 2 right / or left
3 seater left / or right + chaiselongue wide right / or left

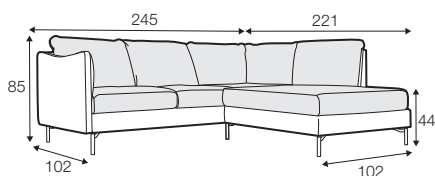

set 3 right / or left
2 seater left / or right + divan right / or left

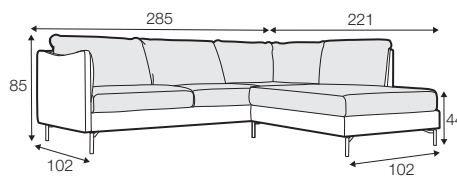

set 4 right / or left
3 seater left / or right + divan right / or left

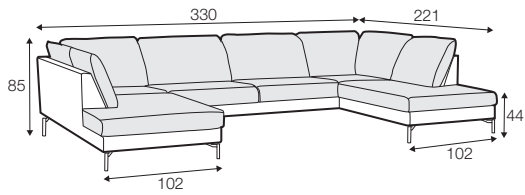

set 6
divan left + 2 seater without armrests + divan right

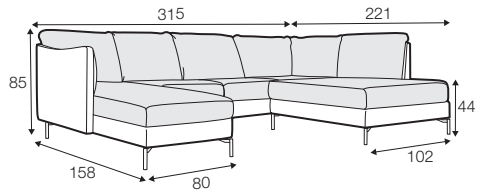

set 7 right / or left
chaiselongue left / or right + 2 seater without armrests
+ divan right / or left

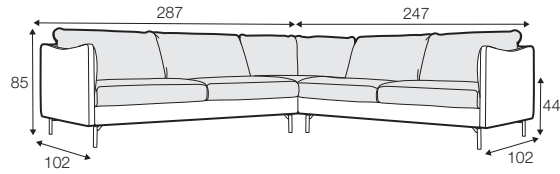

set 8 right / or left
3 seater left / or right + corner 90° no. 1 + 2 seater right / or left

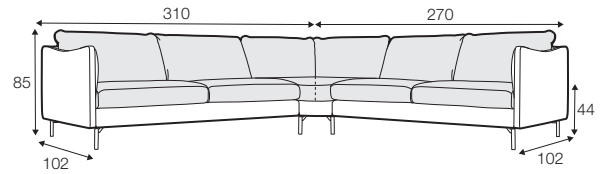

set 9 right / or left
3 seater left / or right + corner 90° no. 2 + 2 seater right / or left

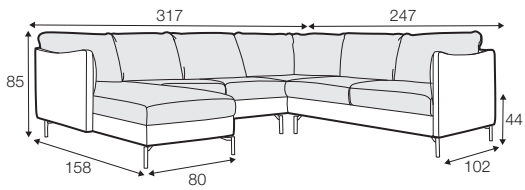

set 10 left / or right
chaiselongue left / or right + 2 seater without armrests
+ corner 90° no. 1 + 2 seater right / or left

modular system

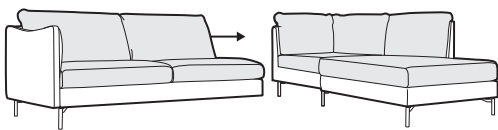

elements of the modular system

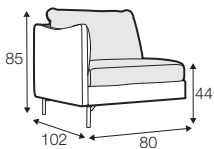

armchair
left / or right

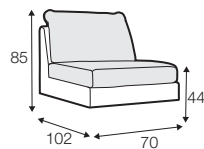

armchair
without armrests

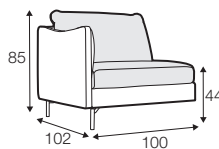

armchair wide
left / or right

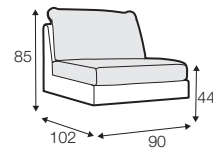

armchair wide
without armrests

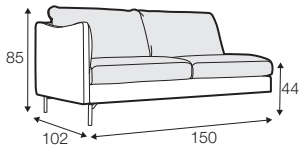

2 seater left / or right

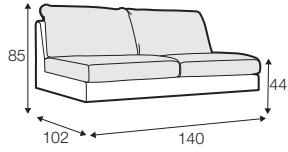

2 seater
without armrests

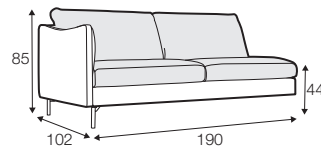

3 seater left / or right

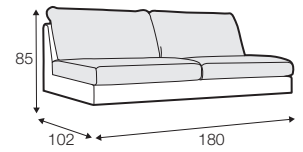

3 seater
without armrests

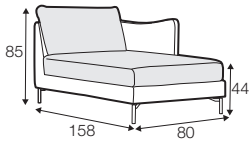

chaiselongue right / or left

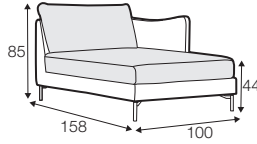

chaiselongue wide
right / or left

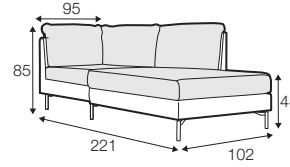

divan right / or left

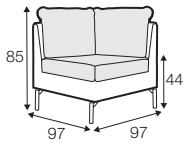

corner 90° no. 1

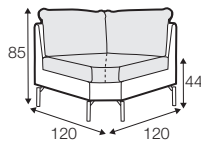

corner 90° no. 2

extra dimensions

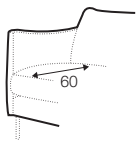

depth of seat

accessories

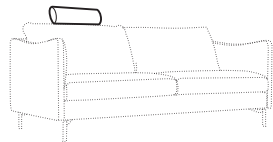

headrest L-62

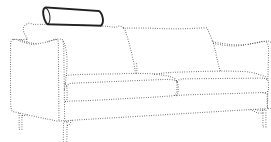
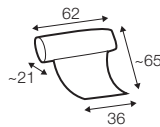

headrest L-77

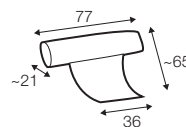

legs

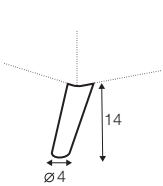

no. 141A
wood
recommended

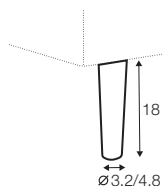

no. 141B
wood

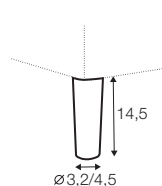

no. 153
wood

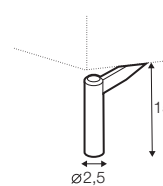

no. 145A
metal chrome,
painted black

profile

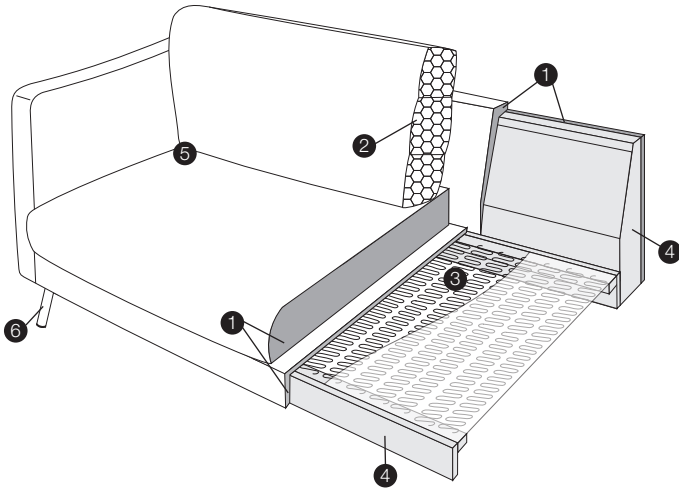

standard

- 1. polyurethane foam/ high resilient polyurethane foam
- 2. silicone balls
- 3. springs
- 4. solid wood and wood based elements
- 5. fabric
- 6. solid wood or metal legs

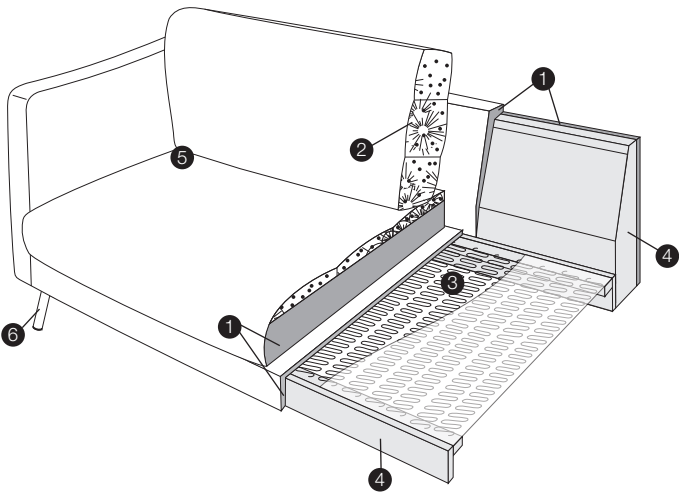

lux

- 1. polyurethane foam/ high resilient polyurethane foam
- 2. cushion chamber with mix of feather and silicone balls
- 3. springs
- 4. solid wood and wood based elements
- 5. fabric
- 6. solid wood or metal legs

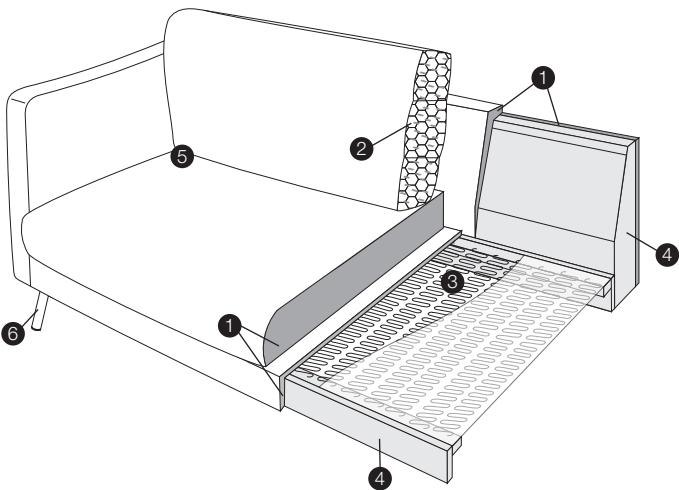

classic

- 1. polyurethane foam/ high resilient polyurethane foam
- 2. silicone balls with foam sticks
- 3. springs
- 4. solid wood and wood based elements
- 5. fabric
- 6. solid wood or metal legs